

creative ambition™ 640

User's Guide



IMPORTANT SAFETY INSTRUCTIONS

Read all instructions before using this household sewing machine.

When using an electrical appliance, basic safety precautions should always be followed, including the following:

Keep the instructions at a suitable place close to the machine. Make sure to hand them over if the machine is given to a third party.

This appliance is intended for use by adults. The appliance can be used with adult supervision by (i) children aged from 8 to 12 years and (ii) persons with reduced physical, sensory or mental capabilities or lack of experience and knowledge if they have been given instruction concerning use of the appliance in a safe way and understand the hazards involved. Cleaning and user maintenance shall not be made by children without supervision. It is not allowed for anyone to play with the machine. Children up to 8 years are not allowed to use the machine.

DANGER - TO REDUCE THE RISK OF ELECTRIC SHOCK:

- A sewing machine should never be left unattended when plugged in. The electrical socket, to which the machine is plugged in should be easily accessible. Always unplug this sewing machine from the electric outlet immediately after using and before cleaning, removing covers, lubricating or when making any other user servicing adjustments mentioned in the instruction manual.

WARNING –TO REDUCE THE RISK OF BURNS, FIRE, ELECTRIC SHOCK, OR INJURY TO PERSON:

- Do not allow to be used as a toy. Close attention is necessary when this sewing machine is used by or near children.
- Use this sewing machine only for its intended use as described in this manual. Use only attachments recommended by the manufacturer as contained in this manual.
- Never operate this sewing machine if it has a damaged cord or plug, if it is not working properly, if it has been dropped or damaged, or dropped into water. Return the sewing machine to the nearest authorized dealer or service center for examination, repair, electrical or mechanical adjustment.
- Never operate the sewing machine with any air openings blocked. Keep ventilation openings of the sewing machine and foot control free from the accumulation of lint, dust, and loose cloth.
- Keep fingers away from all moving parts. Special care is required around the sewing machine needle.
- Always use the proper needle plate. The wrong plate can cause the needle to break.
- Do not use bent needles.
- Do not pull or push fabric while stitching. It may deflect the needle causing it to break.
- Wear safety glasses.
- Switch the sewing machine off ("0") when making any adjustment in the needle area, such as threading needle, changing needle, threading bobbin, or changing presser foot, etc.
- Never drop or insert any object into any opening.
- Do not use outdoors.
- Do not operate where aerosol (spray) products are being used or where oxygen is being administered.
- To disconnect, turn all controls to the off ("0") position, then remove plug from outlet.
- Do not unplug by pulling on cord. To unplug, grasp the plug, not the cord.

- The foot control is used to operate the machine. Never place other objects on the foot control.
- Do not use the machine if it is wet.
- If the LED lamp is damaged or broken, it must be replaced by the manufacturer or its service agent or a similarly qualified person, in order to avoid a hazard.
- If the cord connected with the foot control is damaged, it must be replaced by the manufacturer or its service agent or a similarly qualified person, in order to avoid a hazard.

For Overlock Machines only:

- Never operate without a cutter cover or a securely installed coverstitch table.

SAVE THESE INSTRUCTIONS

TABLE OF CONTENTS

1	Introduction	6	USB Port.....	25	
	Machine Overview.....	6	USB Embroidery Stick.....	25	
	Front.....	6	Connect to and Remove From USB Port	25	
	Top Parts	7	Complimentary Embroidery Intro		
	Rear Side	7	Software (PC)	25	
	Accessory Tray.....	7	How to Update Your Machine	25	
	Parts of the Embroidery Unit.....	8	Updating Instructions	26	
	Accessories.....	8	Buttons and Indicators.....	27	
	Included Accessories	8	Needle Stop Up/Down Button with		
	Included Hoop	9	Indicator	27	
	Presser Feet	9	Tie-off Button	27	
	Stitch Overview	11	Thread Snips Button with Indicator	27	
	Utility Stitches.....	11	Start/Stop Button	28	
	Quilt Stitches.....	12	Reverse Button with Indicator	28	
	Needle Art Stitches	13	Sewing Mode/Embroidery Stitch-out		
	Satin Stitches	13	Mode Button	28	
	Decorative Stitches	13	Sequencing/Embroidery Edit Mode		
	Optional Feet Stitches	13	Button.....	28	
	Alphabets	14	Alphabet Mode, Sequencing Button	28	
	Block	14	Settings Menu Button.....	28	
	Cyrillic.....	14	Graphic Display	28	
2	Preparations	15	Stitch Width/Stitch Positioning Buttons	28	
	Unpacking.....	15	Cursor Buttons	28	
	Connect the Power Cord and Foot		Stitch Length/Stitch Density Buttons	28	
	Control	15	Direct Selection Buttons	28	
	Pack Away After Sewing	15	Load Button	28	
	LED Lights	15	Save Personal Stitch or Sequence button.....	29	
	Free Arm	16	Delete Button	29	
	Mounting Machine in Sewing Cabinet.....	16	Mirror Side to Side Button.....	29	
	Thread Cutter.....	16	Mirror End to End Button	29	
	Spool Pins.....	17	Alt Button	29	
	Horizontal Position.....	17	Info Button.....	29	
	Vertical Position	17	Wheel Buttons.....	29	
	Auxiliary Spool Pin.....	18	OK Button.....	29	
	Threading the Machine.....	18	Speed Control Lever	29	
	Needle Threader.....	19	Settings Menu	30	
	Threading for Twin Needle	20	Thread Tension	30	
	Bobbin Winding.....	21	Twin Needle	30	
	Winding From Horizontal Position	21	Stitch Width Safety	30	
	Winding Through the Needle.....	21	Automatic Stop for Cut	31	
	Inserting the Bobbin.....	22	Language	31	
	IDT™ System (Integrated Dual Feed)	22	Audible Alarm	31	
	Engaging the IDT™ System.....	22	Contrast.....	31	
	Disengaging the IDT™ System	22	Software Version	31	
	Needles	23	Hoop Positions.....	31	
	Important Needle Information	23	3	Sewing Mode	32
	Changing the Needle	23	Select a Stitch.....	32	
	Lowering Feed Teeth	24	Sewing Recommendations	32	
	Presser Foot Pressure.....	24	Stitch Adjustments.....	33	
	Presser Foot Lift	24	Stitch Width/Stitch Positioning	33	
	Changing the Presser Foot.....	24	Stitch Length/Stitch Density	33	
	Remove Presser Foot.....	24	Elongation	33	
	Attach Presser Foot.....	24	Mirroring.....	33	
			Thread Tension	34	
			Personal Stitch.....	34	
			Save Personal Stitch	34	
			Overwrite Personal Stitch.....	34	

Load Personal Stitch	34	Rotate	54
Sewing Techniques	35	Design Height	54
Three-Step Zigzag Stitch	35	Design Width	54
Buttonholes	35	Move	54
Sew On a Button	37	Mirroring	54
Darning	38	Embroidery Pop-Ups	55
Sewing Hems in Heavy Fabric	38		
Handlook Quilting	38		
Free-Motion	39		
Free-Motion Stippling	39		
Blind Hem Stitch	40		
Sewing in Zippers	40		
Sewing Pop-Ups	41		
4 Sequencing	42	7 Maintenance	57
Create a Sequence	42	Cleaning the Machine	57
Using the Alphabet	42	Cleaning the Bobbin Area	57
Create a Text Sequence	43	Cleaning Under the Bobbin Area	57
Select Character Set and Font	43	Replacing the Needle Plate	58
Adjust Text and Stitches	43	Troubleshooting	58
Delete a Stitch or Letter in a Sequence	43	Technical Specification	60
Manage Your Sequences	43		
Save Sequence	43		
Load Sequence	43		
Sewing a sequence	44		
Sequencing Pop-Ups	44		
5 Embroidery Preparations	45		
Embroidery Unit Overview	45		
Embroidery Hoop Overview	45		
Designs	45		
Embroidery Collection	45		
Download Backup Designs	45		
Connect the Embroidery Unit	46		
Remove the Embroidery Unit	46		
Attach Embroidery/Free-Motion Foot 6	46		
To Hoop the Fabric	47		
Attach/Remove the Hoop	47		
6 Embroidering	48		
Design Information	48		
Embroidery Stitch-Out	49		
Load a Design	49		
Load an Embroidery Font	50		
Embroidery Text Editor	50		
Hoop Sizes	51		
Hoop Positions	51		
Stitches Left in Color Block	51		
Current Color	51		
Orbit to Check Position	52		
Basting	52		
Monochrome	52		
Speed Control	52		
Thread Tension	52		
Getting Started Embroidering	53		
Embroidery Edit	54		

1 Introduction

Machine Overview

Front

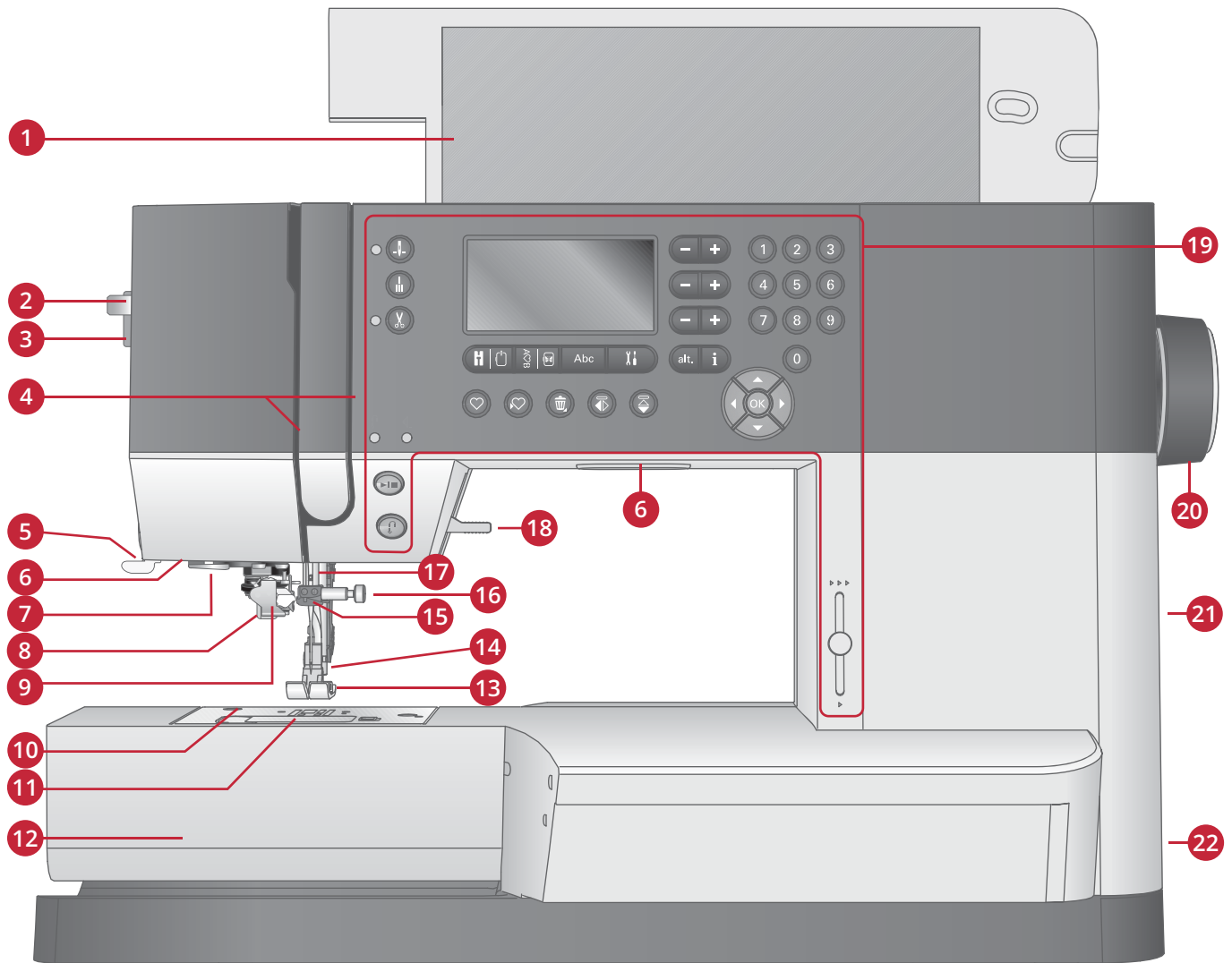

- | | |
|-------------------------------|-------------------------------------------------------------|
| 1. Lid with stitch overview | 13. Presser foot |
| 2. Needle threader lever | 14. Presser foot bar and presser foot holder |
| 3. Presser foot pressure dial | 15. Needle thread guide |
| 4. Threading slots | 16. Needle screw |
| 5. Thread cutter | 17. Needle bar |
| 6. LED lights | 18. Presser foot lift |
| 7. Needle threader guide | 19. Buttons and graphic display |
| 8. Buttonhole lever | 20. Hand wheel |
| 9. Built-in needle threader | 21. USB port |
| 10. Needle plate | 22. Main switch, connectors for power cord and foot control |
| 11. Bobbin cover | |
| 12. Free arm | |

Top Parts

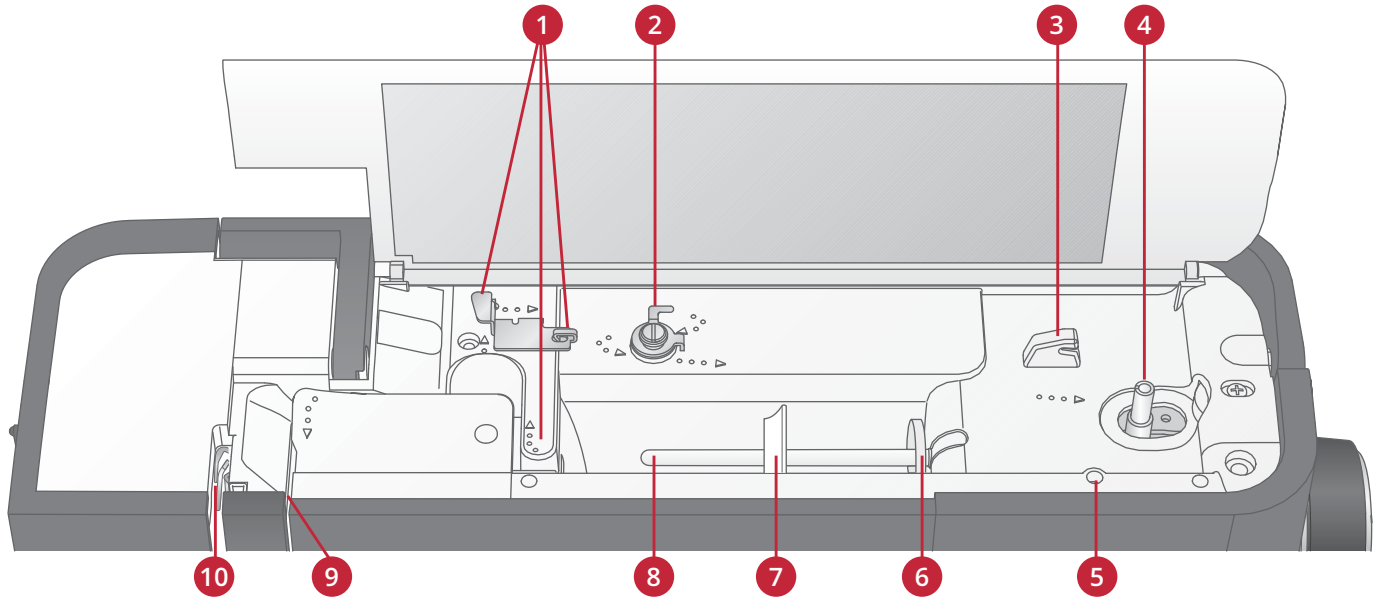

- | | |
|------------------------------------------------|-------------------------|
| 1. Thread guides | 6. Felt pad |
| 2. Bobbin winder thread guide and tension disc | 7. Spool cap |
| 3. Bobbin thread cutter | 8. Spool pin |
| 4. Bobbin winder lever and bobbin spindle | 9. Thread tension discs |
| 5. Hole for auxiliary spool pin | 10. Take-up lever |

Rear Side

1. Handle
2. Presser foot lift
3. IDT™ system
4. Embroidery unit connection socket
5. Slide for lowering the feed teeth

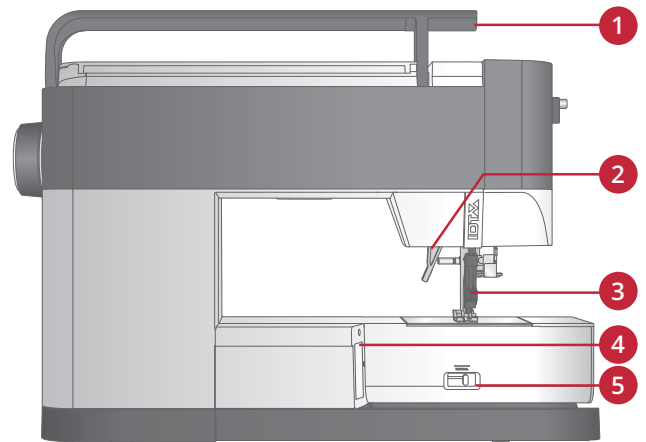

Accessory Tray

Store the accessories in the tray so they are easily accessible.

1. Space for accessories
2. Hook

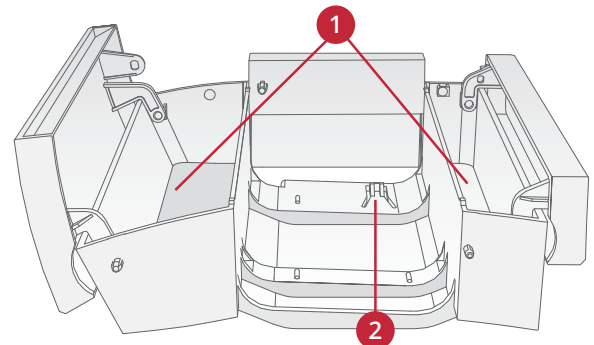

Parts of the Embroidery Unit (type EU-3P)

1. Embroidery unit release button
2. Level adjusting feet
3. Embroidery unit socket
4. Embroidery hoop connection assembly
5. Embroidery arm

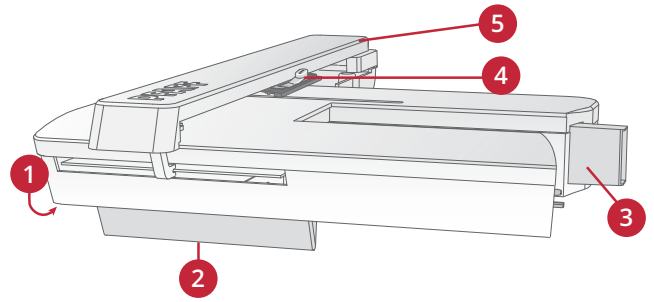

Accessories

Included Accessories

1. Thread net
2. Edge guide
3. Felt pad (2)
4. Screwdriver
5. Auxiliary spool pin
6. Seam ripper
7. Brush. Use the sharp edge of the brush to clean the area around the feed teeth.
8. Bobbins (5, one is on the machine)
9. Screwdriver for needle plate
10. Spool cap, small
11. Spool cap, large
12. USB embroidery stick with embroidery designs and PFAFF® **creative™ ambition 640** embroidery collection booklet
13. Multi-purpose tool
14. Long needle clamp screw for zig-zag free-motion sewing

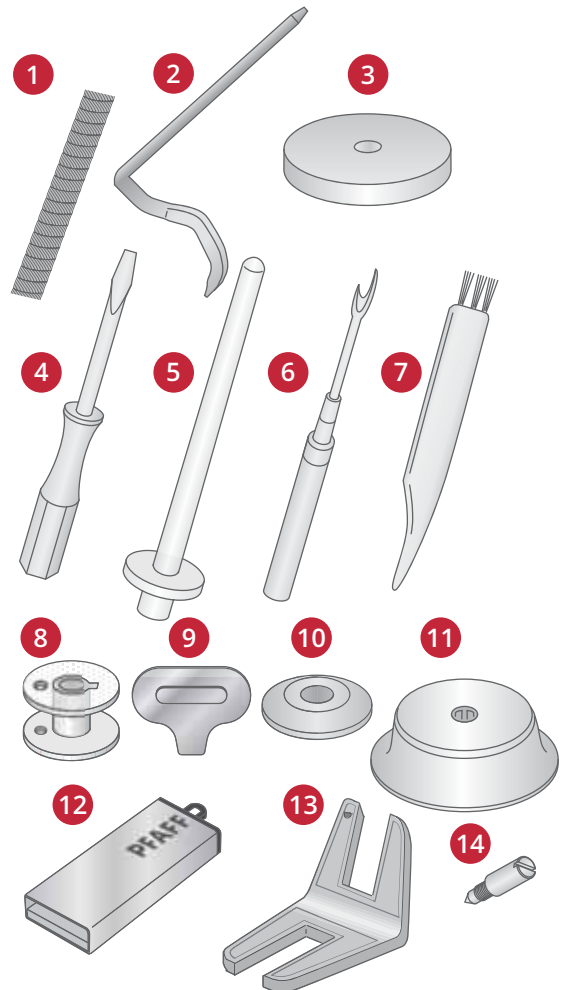

Included Accessories not in Picture

- Foot control
- Power cord
- Needles
- Cover to use when storing the machine

Included Hoop

creative™ MASTER HOOP (240x150 mm)

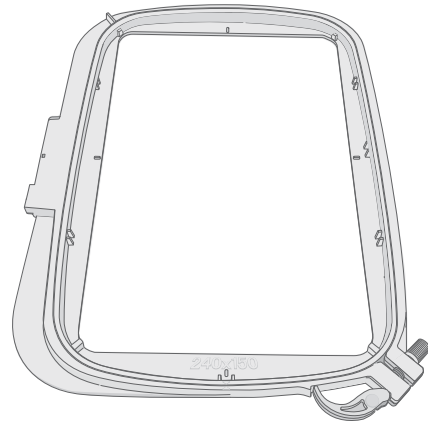

Presser Feet



0A - Standard Presser Foot for IDT™ System
(attached on the machine upon delivery)

This foot is used mainly for straight stitching and zigzag stitching with a stitch length longer than 1.0 mm.



1A - Fancy Stitch Foot for IDT™ System

This foot is used for decorative stitches. The groove on the underside of the foot is designed to flow smoothly over the stitches.



2A - Fancy Stitch Foot

When sewing decorative stitches or short zigzag stitches and other utility stitches with less than 1.0mm stitch length, use this foot. The groove on the underside of the foot is designed to flow smoothly over the stitches.

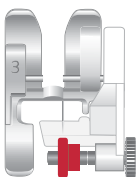

3 – Blindhem Foot for IDT™ System

This foot is used for blindhem stitches. The toe on the foot guides the fabric. The red guide on the foot is designed to ride along the fold of the hem edge.



4 – Zipper Foot for IDT™ System

This foot can be snapped on either the right or the left of the needle, making it easy to sew close to both sides of the zipper teeth. Move the needle position to the right or left to sew closer to zipper teeth.

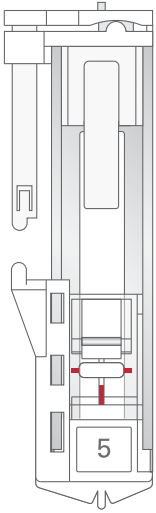

5 – One Step Buttonhole Foot

This foot has a space in the back for a button used to set the size of the buttonhole. The machine will sew a buttonhole to fit that button size. Used to sew buttonholes up to 25mm.



5M - Manual Buttonhole Foot

This foot is used for sewing manual buttonholes longer than 25 mm. Use the markings on the foot to position the garment edge. The finger on the back of the foot holds cording for corded buttonhole.

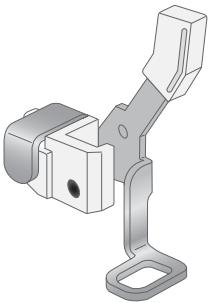





















6 – Embroidery/Free-Motion Foot

















This foot is used for embroidery and free-motion sewing. This foot can also be used for darning.

Note: When free-motion sewing using zigzag, replace the short needle clamp screw with the long needle clamp screw found in the included accessories.































Stitch Overview

Utility Stitches



Stitch	No	Name	Description
	1	Straight stitch	For seaming and topstitching. Select from 29 different needle positions.
	2	Stretch triple straight stitch	Reinforced seam. Topstitching.
	3	Straight stitch reverse	Sew continuous reverse.
	4	Zigzag stitch	Reinforce seams, clean finish, stretch sewing, lace insertion.
	5	Zigzag stitch, right or left needle position	Reinforce seams, clean finish, stretch sewing.
	6	Z-zigzag stitch	Appliqué, couching, eyelets.
	7	Stretch triple zigzag stitch	Elastic stitch for decorative hems or topstitching.
	8	Three-step zigzag stitch	Sewing elastic, darning, patching.
	9	Elastic stitch	Sewing elastic, darning, patching.
	10	Triple stretch stitch	Sewing elastic, darning, patching and decorative sewing.
	11	Honeycomb stitch	Decorative stitch for stretch fabrics and hems. Also used with elastic thread in the bobbin.
	12	Bridging stitch	Joining fabrics and quilt batting, decorative stitch for quilting, hemstitching.
	13	Foundation elastic stitch	Joining stitch for undergarments, terry cloth, leather, bulky fabrics where overlapping the seams.
	14	Crosshem stitch	Elastic decorative hem for stretch fabrics.
	15	Blindhem stitch	Sewing blindhems on woven fabrics.
	16	Elastic blindhem stitch	Sewing blindhems on stretch fabrics.
	17	Stretch tricot stitch	Sewing seams on stretch fabrics.
	18	Closed overlock	Seam and overcast stretch fabrics in one step.
	19	Closed overlock	Seam and overcast in one step with reinforced edge.
	20	Elastic overcast	Seam and overcast stretch fabrics in one step.

Stitch	Nº	Name	Description
	21	Overlock	Seam and overcast in one step, patch, hem.
	22	Closed overlock	Seam and overcast in one step, patch, hem.
	23	Stretch knit overlock	Seam and overcast stretch fabrics in one step.
	24	Closed overlock blind hem	Create decorative overlock blindhem for stretch fabrics.
	25	Linen buttonhole	Buttonhole for blouses, shirts and linen.
	26	Standard buttonhole	Basic buttonhole for blouses, shirts and jackets. Also for pillow cases.
	27	Rounded buttonhole with lengthwise tack	Buttonhole for garments.
	28	Eyelet buttonhole with pointed	Tailors buttonhole or decorative buttonhole.
	29	Eyelet buttonhole with lengthwise tack	Tailors buttonhole for jackets and trousers.
	30	Rounded buttonhole	Buttonhole for light garments or jackets.
	31	Stretch buttonhole	Buttonhole for stretch fabrics.
	32	Button sewing	Sew on buttons or tacking.
	33	Eyelet	Heirloom sewing decorative trim.
	34	Programmable darning stitch	Darning holes or damaged fabric.
	35	Programmable reinforced darning stitch	Reinforced darning holes or damaged fabric.
	36	Bartack	Automatically reinforce seams and pockets.
	37	Denim bartack	Automatically reinforce seams and pockets decoratively.

Quilt Stitches

														
38	39	40	41	42	43	44	45	46	47	48	49	50	51	52
														
53	54	55	56	57	58	59	60	61	62	63	64	65	66	67

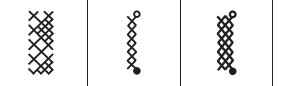
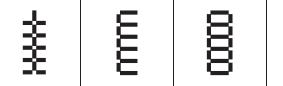
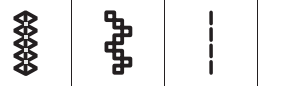

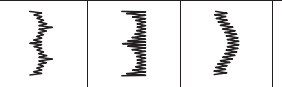
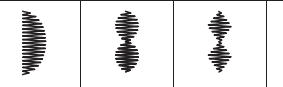
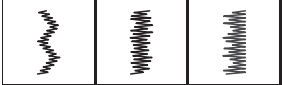

Needle Art Stitches

	68	69	70	71		72	73	74	75		76	77	78	79		80	81	82
	83	84	85															



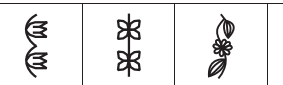

Satin Stitches

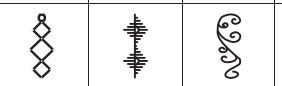
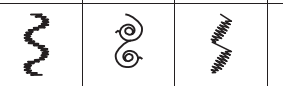
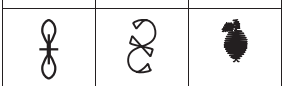
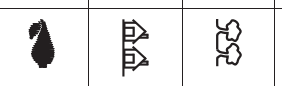
	86	87	88	89	90		91	92	93	94	95		96	97	98	99	100
	101	102	103	104	105												

Decorative Stitches

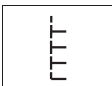
	106	107	108	109	110		111	112	113	114	115		116	117	118	119	120
	121	122	123	124	125		126	127	128	129	130		131	132	133	134	135
	136	137	138	139	140		141	142	143	144	145						

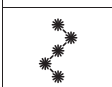
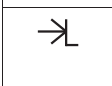
Optional Feet Stitches

	146	Beading stitch, 4-6mm	For sewing on pearls, beads etc. Requires optional Beading foot (part number 820605-096)
	147	Candlewicking	Create the look of hand embroidered French knots. Requires optional Candlewicking Foot for IDT™ system (part number 820613-096).
	148	Candlewicking	Create the look of hand embroidered French knots. Requires optional Candlewicking Foot for IDT™ system (part number 820613-096).
	149	Joining and edging stitch	For joining two pieces of fabric. Requires optional Join and Fold Edging Foot for IDT™ system (part number 820931-096).
	150	Joining and edging stitch	For joining two pieces of fabric. Requires optional Join and Fold Edging Foot for IDT™ system (part number 820931-096).

Alphabets

Block

ABCDEFGHIJKLMNOPQRSTUVWXYZ
abcdefghijklmnopqrstuvwxyz
À Á Â Ã Ä Å Æ Ø Ñ Ò Ó Ô Õ Ö × Ø Ù Ú Û Ü Ý Þ ß à á â ã ä å æ ç è é ê ë ì í î ï ð ñ ò ó ô õ ö ÷ ø ù ú û ü ý þ ß à á â ã ä å æ ç è é ê ë ì í î ï ð ñ ò ó ô õ ö ÷ ø ù ú û ü ý þ ß
1234567890.,- _

Cyrillic

А Б В Г Д Е Ж З И Й К Л М Н О П Р С Т У Ф Х Ц Ч
Ш Щ Ъ Ы Ь Э Ю Я
а б в г д е ж з и й к л м н о п р с т у ф х ц ч ш щ ъ ы ь э ю я
1234567890&?!' @.,- _

2 Preparations

Unpacking

1. Place the box on a steady, flat surface. Lift the machine out of the box and remove the outer packaging.
2. Remove all outer packing material and the plastic bag.

Note: Your PFAFF® creative™ ambition 640 machine is adjusted to provide the best stitch result at normal room temperature. Extreme hot and cold temperatures can affect the sewn result.

Note: Some fabrics have a lot of excess dye which can cause discoloration on other fabric but also on your sewing machine. This discoloring may be very difficult or impossible to remove. Fleece and denim fabric, especially red and blue, often contain a lot of excess dye. If you suspect that your fabric/ready-to-wear garment contains a lot of excess dye, always pre-wash it before sewing to avoid the discoloring.

Connect the Power Cord and Foot Control

Among the accessories you will find the power cord and the foot control.

Note: Consult a qualified electrician if in doubt as how to connect the machine to the power source. Unplug the power cord when the machine is not in use.

For this sewing machine, foot control model C-9000 manufactured by CHIEN HUNG TAIWAN Ltd must be used.

1. Connect the foot control cord to the front socket on the bottom right side of the machine (A).
2. Connect the power cord to the rear socket on the bottom right side of the machine (B). Plug the cord into the wall socket.
3. Press the ON/OFF switch to ON to turn on power and light (C).

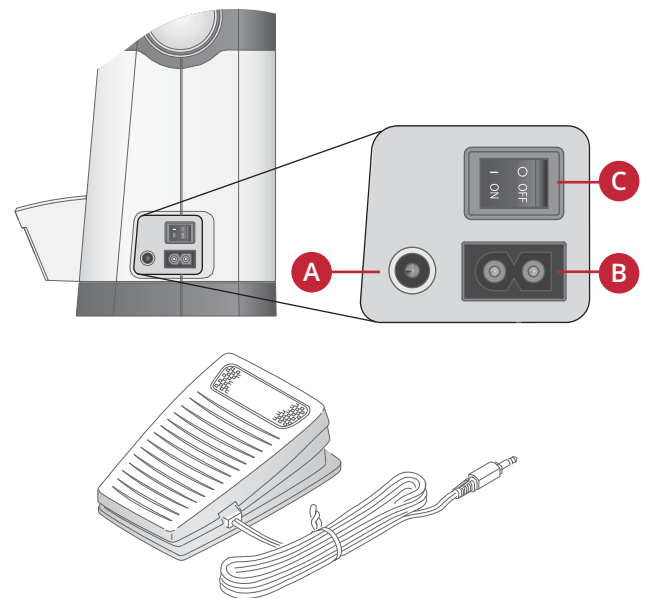

For the USA and Canada

This sewing machine has a polarized plug (one blade wider than the other). To reduce the risk of electric shock, this plug is intended to fit in a polarized outlet only one way. If the plug does not fit fully in the outlet, reverse the plug. If it still does not fit, contact a qualified electrician to install the proper outlet. Do not modify the plug in any way.

Pack Away After Sewing

1. Switch the main switch off.
2. Unplug the cord from the wall socket and then from the machine.
3. Unplug the foot control cord from the machine. Wind the cord around the foot control for easy storage.
4. Place all accessories in the accessory tray. Slide the tray on to the machine around the free arm.
5. Place the foot control in the space above the free arm.
6. Put on the cover.

LED Lights

Your machine has LED lights which distribute the light evenly over the sewing area and eliminates shadows.

Free Arm

To use the free arm, slide off the accessory tray. When attached, a hook keeps the accessory tray securely attached to the machine. Remove the tray by sliding it to the left.

Mounting Machine in Sewing Cabinet

There are two holes on the underside of the machine designed for mounting the machine into a sewing cabinet. Attach the machine with M6 screws.

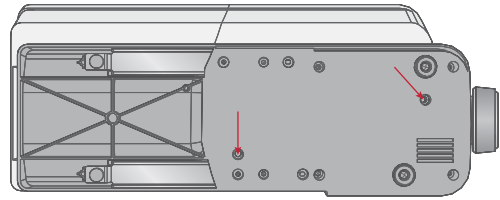

Thread Cutter

To use the thread cutter, pull the thread from back to front as shown (A).

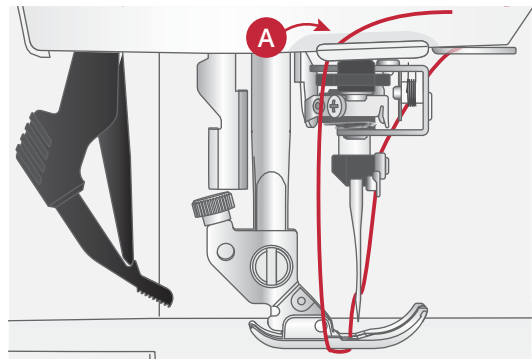

Spool Pins

Your machine has two spool pins, a main spool pin and an auxiliary spool pin. The spool pins are designed for all types of thread. The main spool pin is adjustable and can be used both in a horizontal position (the thread reels off the spool) and a vertical position (the thread spool rotates). Use the horizontal position for normal threads and the vertical position for large spools or specialty threads.

Horizontal Position

Place a felt pad and the thread spool on the spool pin. Make sure that the thread reels off from the front of the spool (A) and slide on a spool cap.

Note: Not all thread spools are manufactured in the same way. If you experience problems with the thread, turn the spool so that the thread reels off in the opposite direction or place the thread in the vertical position.

Depending on the size of thread spool, reverse the direction of the spool cap (B).

Use the small cap when you use cross wound thread (C).

Set the thread net over the spool if thread unrolls easily (D).

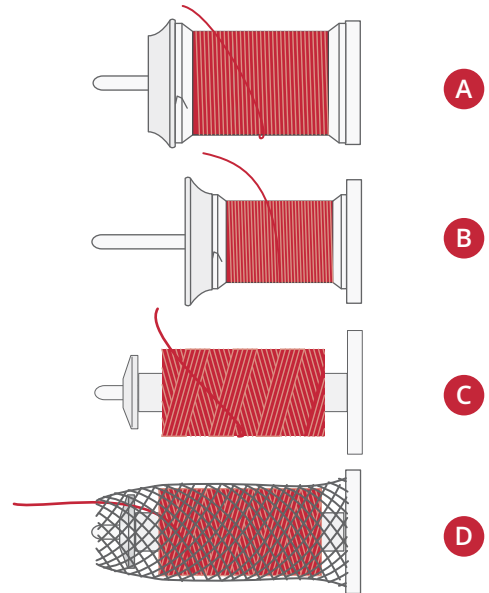

Vertical Position

Raise the spool pin to the vertical position. Place a felt pad under the thread spool. This is to prevent the thread from reeling off too fast. Do not place a spool cap on top of the spool pin as that would prevent the spool from rotating.

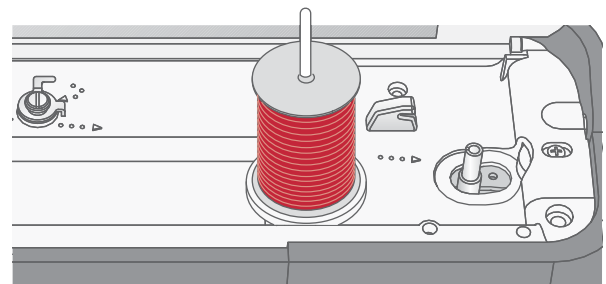

Main spool pin in vertical position.

Auxiliary Spool Pin

The auxiliary spool pin is used when winding a bobbin thread from a second spool of thread or for a second spool when sewing with a twin needle. Insert the auxiliary spool pin into the hole at the top of the machine (A). Place a felt pad under the thread spool.

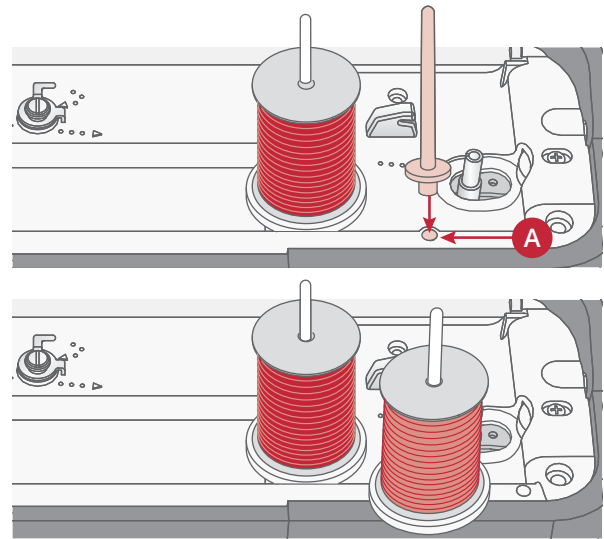

Auxiliary spool pin and main spool pin in vertical position.

Threading the Machine

Make sure that the presser foot is raised and the needle is in its highest position.

1. Place a felt pad and the thread spool on the spool pin and fit a spool cap of the right size and direction.

Note: Hold thread with both hands to prevent it from slacking while threading. This ensures that the thread will be positioned properly in the threading path.

2. Pull the thread under the thread guide (A) from the right to the left.
3. Pull the thread from the right to left along the slot.
4. Pull the thread between the tension discs (B).
5. Thread down through the right-hand threading slot and then upwards through the left-hand threading slot.
6. Bring the thread from the right into the take-up lever (C) and down in the left-hand threading slot into the needle thread guide (D).
7. Thread the needle from front to back. See instructions below how to use the needle threader.

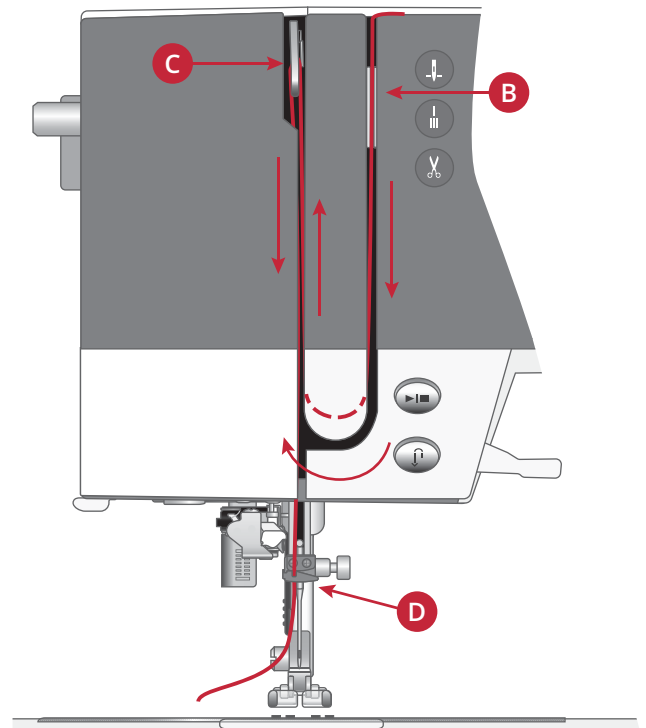
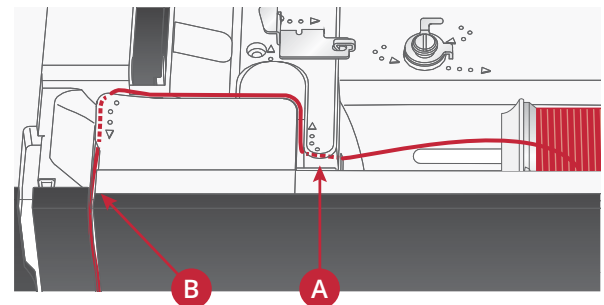

Needle Threader

The needle threader allows you to thread the needle automatically. The needle and presser foot must be in its highest position to use the built-in needle threader. Press the needle up/down button to make sure the needle is fully raised.

1. Make sure the thread is threaded into the needle thread guide (A).
2. Bring the thread to the left, under the thread guide on the needle threader (B). Make sure the thread "clicks" into place.
3. Place the thread from right to left in the next thread guide (C).
4. Bring the thread from back to front into the thread cutter (D).
5. Push the needle threader lever (E) all the way down. The needle threader will go down, encasing the needle and a small hook will pass through the needle eye and catch the thread.
6. Release the lever allowing the needle threader to gently swing back. The hook pulls the thread through the needle eye.
7. Place the thread under the presser foot.

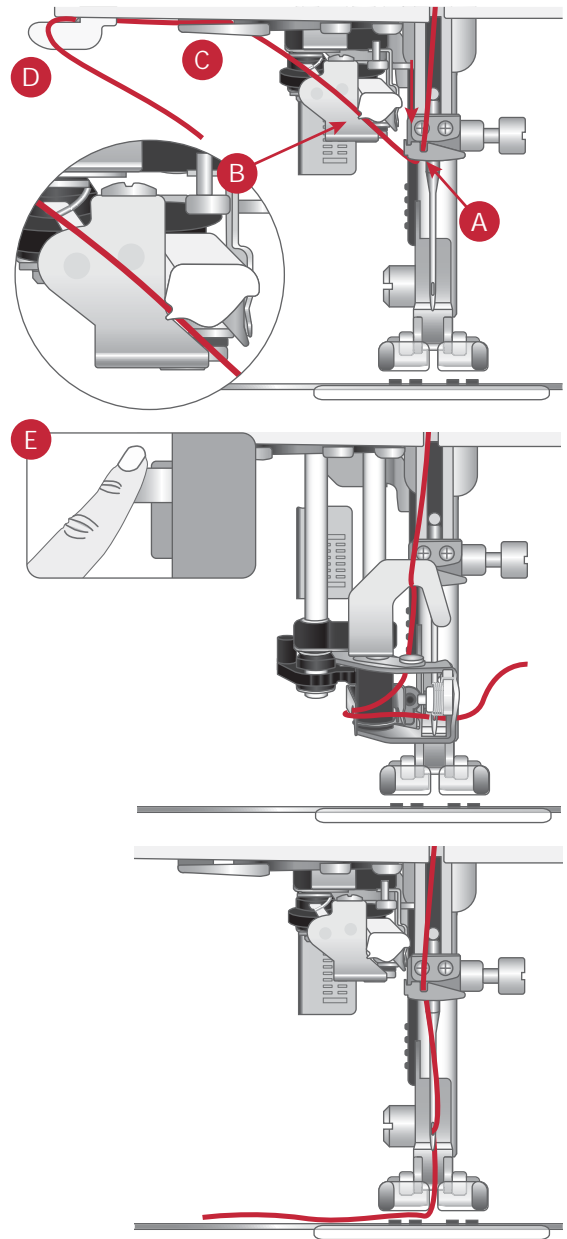

The needle threader is designed to be used with needles size 70-100. You cannot use the needle threader with needles size 65 or smaller, wing needles, twin needles or triple needles.

Specialty threads such as invisible and other stretchy threads, metallic or flat metallic threads, and some heavy weight threads should be threaded manually.

When threading the needle manually, make sure that the needle is threaded from front to back.

*The automatic needle threader cannot be used with all optional accessories available for your **creative™ ambition 640** machine. To avoid damage to the needle threader and/or optional accessory we recommend using the automatic needle threader before attaching the accessory or thread the needle manually.*

Threading for Twin Needle

Replace the sewing needle with a twin needle. Make sure that the presser foot is raised and the needle is in its highest position.

1. Thread the first thread as described on previous page.
2. Thread the needle eye by hand from front to back.
3. Insert the auxiliary spool pin and slide on a felt pad. Place the second thread on the spool pin.
4. Bring thread to the left and pull thread into the thread guide (A) from back to front.
5. Thread the second thread the same way as the first.
6. Make sure that one thread is inside the needle thread guide and the other one outside.
7. Thread needle eye by hand from front to back.

Note: The weight and irregular surface of specialty threads, like metallics, can cause increased tension on the thread. Reducing the tension will prevent needle breakage.

Note: Activate twin needle and select the correct twin needle width in the settings menu. This will limit the width of all stitches for that needle size to prevent damage to presser foot and needle.

Note: Do not use asymmetrical twin needles, since they may damage your sewing machine.

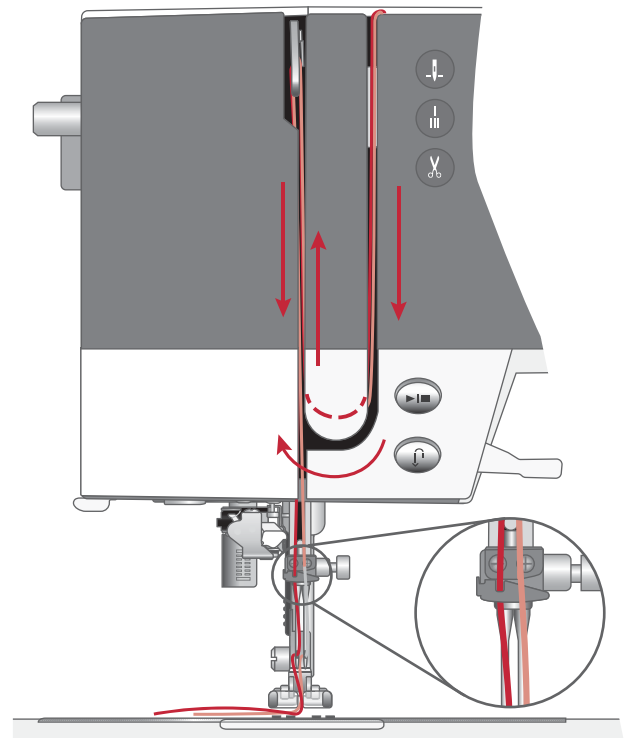
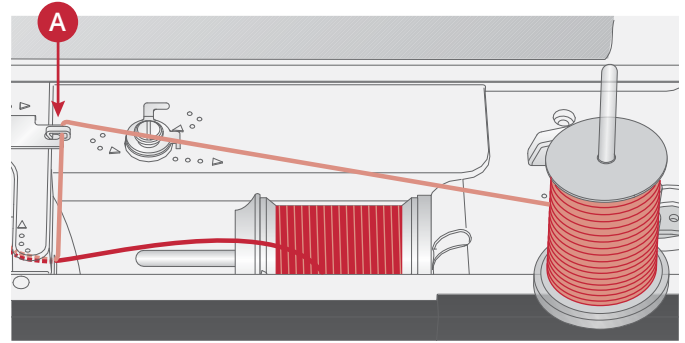

Bobbin Winding

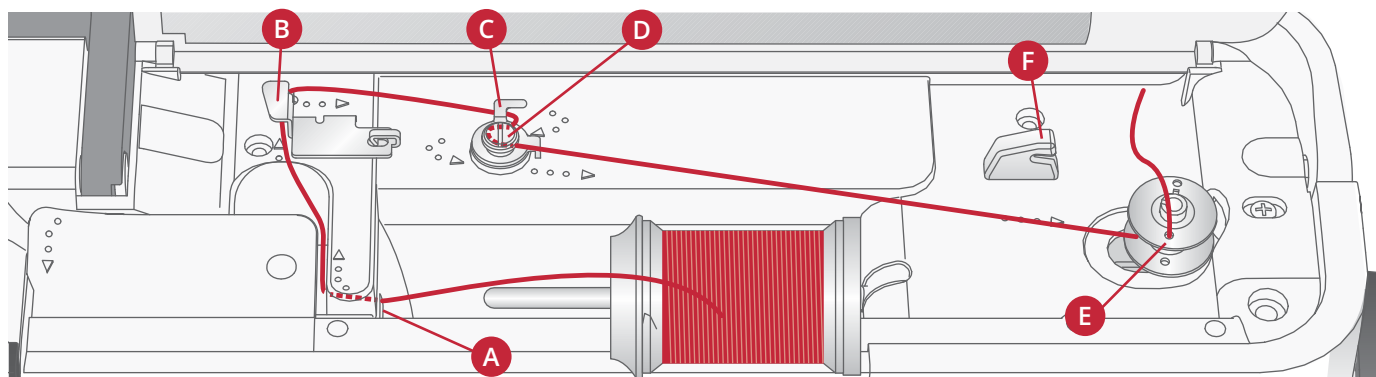

Winding From Horizontal Position

1. Place the felt pad and thread spool on the spool pin in horizontal position. Slide on a spool cap of the right type and direction.
2. Place the thread under the thread guide (A) from right to left. Pull the thread to the rear and around the thread guide (B) from left to right.
3. Pull thread to the right and then through the thread guide (C) from back to front. Pass thread under tension disc (D) in counter clockwise direction.

Note: Make sure the thread is pulled securely inside the tension disc for correct thread tension.

4. Thread through the hole in the empty bobbin (E) from the inside to the outside.
5. Place the bobbin on the bobbin winder spindle.
6. Push the bobbin lever to the right to wind. A pop-up appears on the screen to inform you that bobbin winding is active. Press the foot control or the start/stop button to start winding the bobbin. Hold the end of the thread firmly when starting to wind.

When the bobbin is full, release the foot control or press the start/stop button again to stop. Push the bobbin lever to the left. The pop-up closes. Remove the bobbin and cut the thread using the bobbin thread cutter (F).

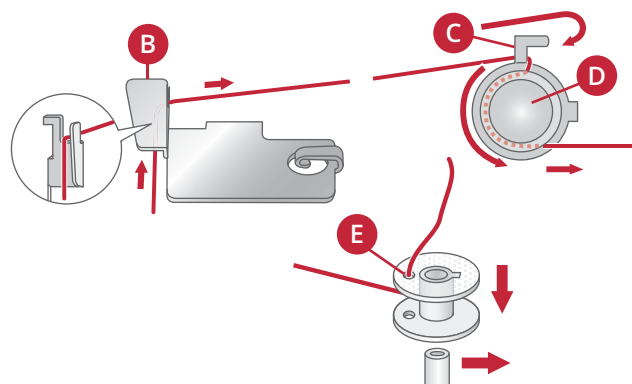

Winding Through the Needle

Make sure that the presser foot is raised and the needle is in its highest position. Bring the thread up from the needle, under the presser foot, upward through the left-hand threading slot and through the bobbin thread guide (A). Then follow step 3 to 6 in above.

Note: Use a metal presser foot when bobbin winding from the needle.

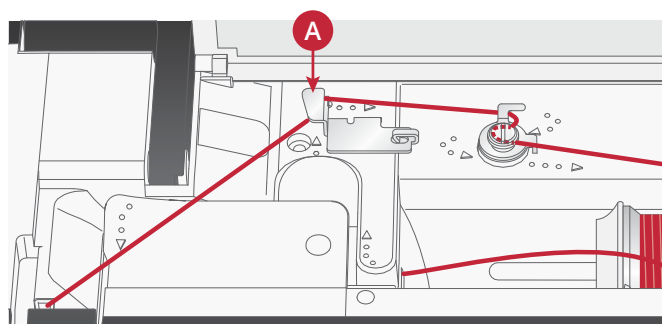

Inserting the Bobbin

Make sure that the needle is fully raised and the machine is turned off before inserting or removing the bobbin.

1. Open the bobbin cover by pushing the release button to the right (A). Remove the cover (B).
2. Insert the bobbin in the bobbin case with the thread running in a counterclockwise direction.
3. With a finger held gently on top of the bobbin, pull the thread into notch (C). Then pull the thread at arrow markings into the needle plate thread guide from (C) to (D). Pull the thread at the arrow markings into the needle plate thread guide from (D) to (E). To cut off excess thread, pull thread to the right over the blade (E).
4. Replace the bobbin cover.

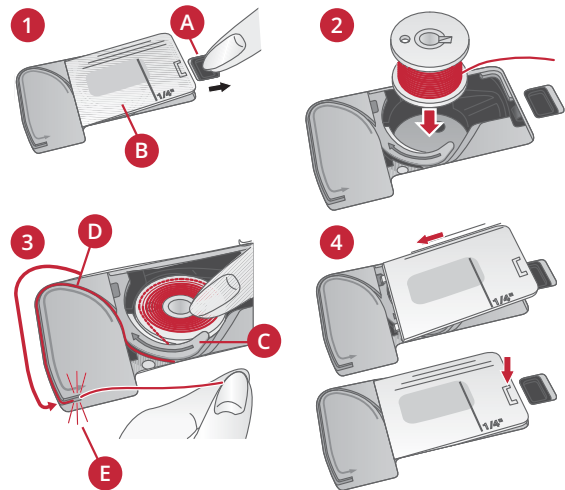

IDT™ System (Integrated Dual Feed)

For sewing any fabric precisely, the PFAFF® **creative™ ambition 640** machine provides the ideal solution: the integrated dual feed, IDT™ system. As on industrial machines, the IDT™ system feeds the fabric from the top and bottom at the same time. The material is fed precisely, eliminating puckering on seams in light weight fabrics such as silk and rayon. The dual feed action of the IDT™ system prevents layers from shifting while sewing, keeping quilt layers aligned and ensuring a more perfect match when sewing plaid or striped fabrics.

Engaging the IDT™ System

Important: For all work with the IDT™ system, use presser feet with the center back cut-out (A).

Raise the presser foot. Press the IDT™ system down until it engages.

Disengaging the IDT™ System

Raise the presser foot. Hold the IDT™ system with two fingers at the ribbed ankle. Pull the IDT™ system down, then pull it away from you to release the IDT™ system slowly upward.

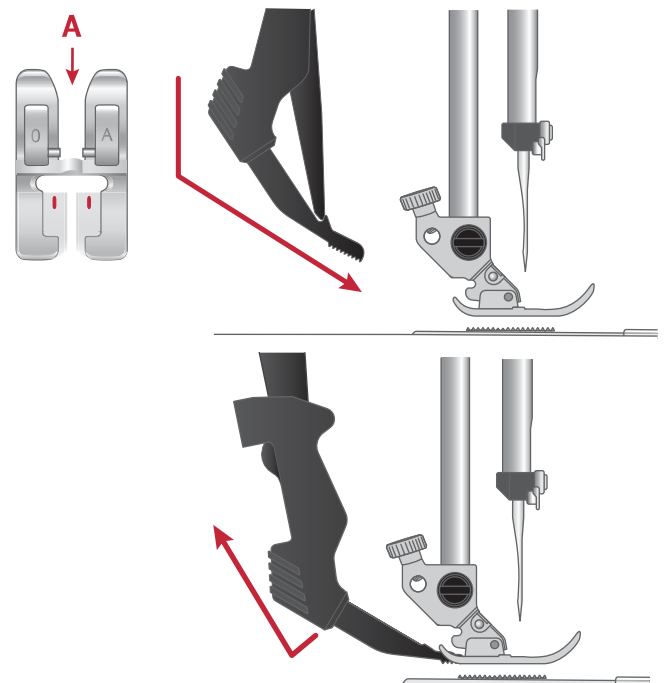

Needles

The sewing machine needle plays an important role in successful sewing. Use only quality needles. We recommend needles of system 130/705H. The needle package included with your machine contains needles of the most frequently used sizes.

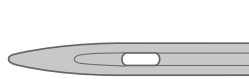

Universal Needle

Universal needles have a slightly rounded point and come in a variety of sizes. For general sewing in a variety of fabric types and weights.



Stretch Needle

Stretch needles have a ball point and a special scarf to eliminate skipped stitches when there is a flex in the fabric. For knits, swimwear, fleece, synthetic suedes and leathers.



Denim Needle

Denim needles have a sharp point to penetrate tightly woven fabrics without deflecting the needle. For canvas, denim, microfibers.



Embroidery Needle

Embroidery needles have a special scarf, a slightly rounded point and a slightly larger eye to avoid damage to thread and materials. Use with metallic and other specialty threads for embroidery and decorative sewing.

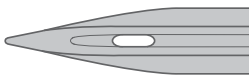

Wing Needle

Wing needles have wide extensions on each side of the needle to poke holes in the fabric when sewing entredeux and other hemstitches on natural fiber fabrics.

Note: For this machine, use wing needle size 100. Wing needle is not included with the machine.

Important Needle Information

Always use a straight needle with a sharp point and make sure the point is not bent or damaged (A).

A damaged needle (B) can cause skipped stitches, breakage or snapping of the thread. It can also damage the needle plate.

Do not use asymmetrical twin needles (C), they can damage your sewing machine.

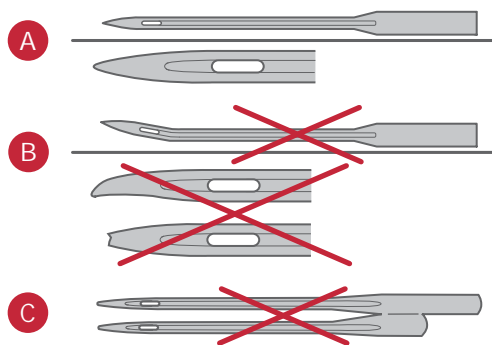

Changing the Needle

1. Use the hole in the multi-purpose tool to hold the needle.
2. Loosen the needle screw. Use the screw driver if necessary.
3. Remove the needle.
4. Insert the new needle, using the multi-purpose tool. Push the new needle upwards with the flat side away from you until it will go no further.
5. Tighten the needle screw as tight as it will go.

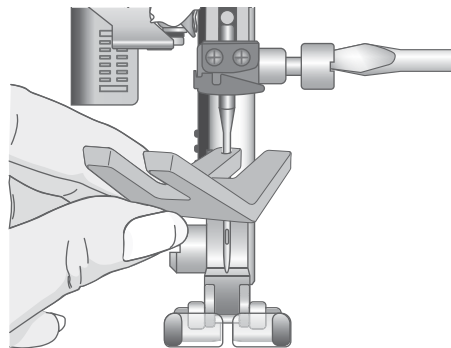

Lowering Feed Teeth

You can lower the feed teeth by moving the switch at the back of the free arm to the left. Move the switch to the right if you wish to raise the feed teeth.

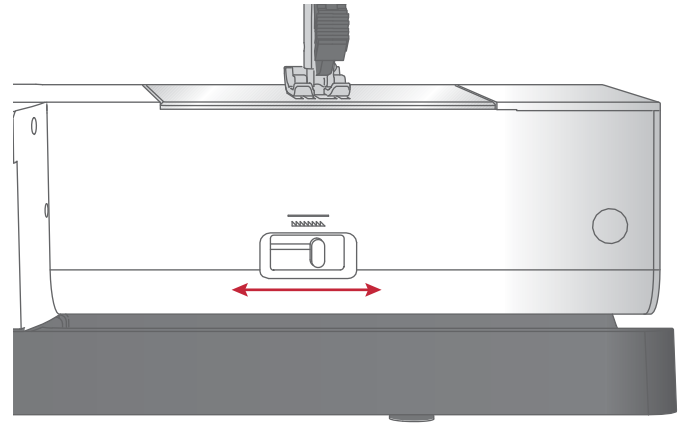

Presser Foot Pressure

The presser foot pressure has been pre-set to the standard value "N". In most cases, you do not need to adjust the presser foot pressure. For specialty techniques, or when sewing on very light or heavy fabric, adjusting the pressure can improve the result. For very light fabrics, turn the dial to a lower number. For heavy fabric, turn the dial to a higher number.

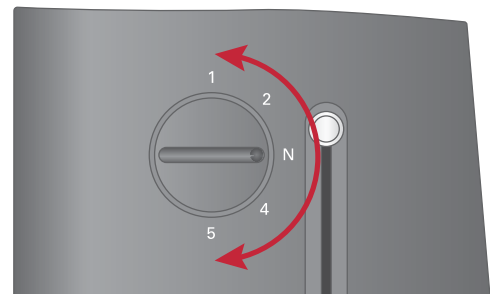

Presser Foot Lift

The presser foot is lowered or raised with the presser foot lift (A). If you are sewing on heavy fabric or several layers of fabric, the presser foot can be raised higher (B) to make it easier to place the fabric underneath the presser foot.

Note: The machine will not start when the presser foot is raised (except for bobbin winding).

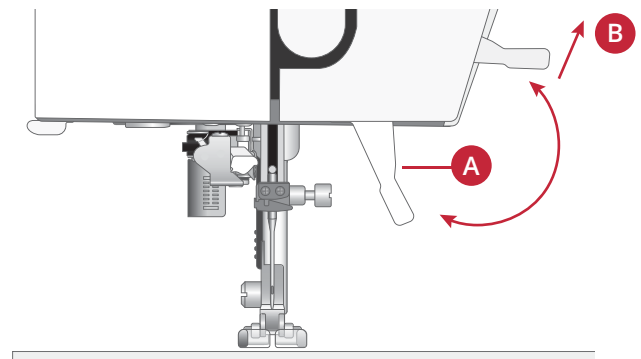

Changing the Presser Foot

Remove Presser Foot

Press the presser foot downwards until it disengages from the presser foot holder.

Attach Presser Foot

Place the presser foot under the presser foot holder (A) lining up the notch (B) with the pins (C). Lower the presser foot lift and the presser foot will engage in the presser foot holder.

Note: Check that the presser foot is properly attached by raising the presser foot lift.

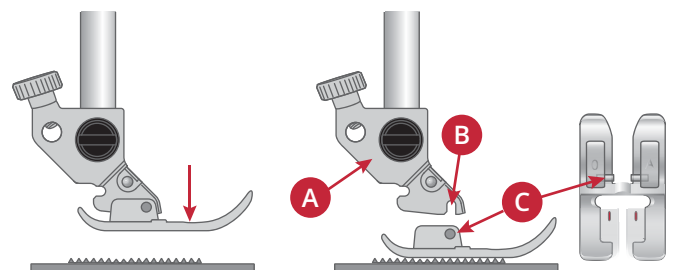

USB Port

Your machine has a USB port to connect your USB embroidery stick.

USB Embroidery Stick

Delivered with your machine is a USB embroidery stick with embroidery designs and PFAFF® **creative™ ambition 640** embroidery collection booklet. Use the stick to store designs and embroidery fonts, or to move files between the computer and sewing machine.

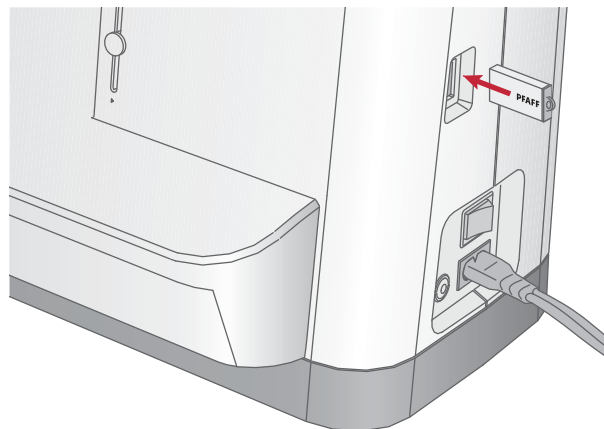

Connect to and Remove From USB Port

Insert the USB embroidery stick in the port with logo facing you. The USB embroidery stick can only be inserted one way – do not force it into the port! To remove, carefully pull the USB embroidery stick out straight.

 *Do not remove the USB embroidery stick while operating the machine or stitching the embroidery, as this can damage the files on your USB embroidery stick and you will lose all current embroidery design information on screen.*

Complimentary Embroidery Intro Software (PC)

A PC embroidery intro software is available for your PFAFF® **creative™ ambition 640** sewing and embroidery machine.

It adds the following features:

- Helps you to adjust your embroideries on the computer before you sew.
- Personalize your embroideries in true 3D in a real hoop.
- Rotate your embroideries to any degree, mirror them from side to side or end to end and scale or resize your embroideries.
- Adjust an unlimited number of designs and lettering.
- Adjust the colors to the thread shades from your preferred manufacturer. Combine with lettering or shapes. ColorSort to intelligently re-sort the color order of a design and reduce the number of thread changes. Select multiple designs and move them as a group.
- Add multi-line lettering with your choice of 4 line types and flexibility to resize and space letters individually. Use the QuickFont wizard to create new fonts for the embroidery intro software from most TrueType® or OpenType® fonts on your computer. Add SuperDesigns to your project. Surround lettering or designs with a frame.

Go to PFAFF® website at www.pfaff.com and look for support and download the software.

More information and detailed installation instructions are available on a separate PDF file on the USB embroidery stick. A printed product code sheet with your unique product activation code is packed with your machine. Please store the printed product code sheet in a safe place. Together with your sales receipt for your embroidery machine, it forms your proof of ownership for your software. The unique product activation code is needed to activate and use your embroidery intro software.

How to Update Your Machine

Be sure to consult the web site at www.pfaff.com and/or your local authorized PFAFF® dealer for updates and upgrades for your machine and owner's manual.

Updating Instructions

- Go to the PFAFF® web site at www.pfaff.com to find information about available updates.
- Follow the update wizard to prepare your USB embroidery stick for the update.
- Insert the prepared USB embroidery stick into the machine before turning it on.
- To start your machine in update mode, press and hold the reverse button and the needle up/down button, while turning on your machine. Keep the reverse button and needle up/down button pressed until update mode is visible on the graphic display. Follow the instructions to update.

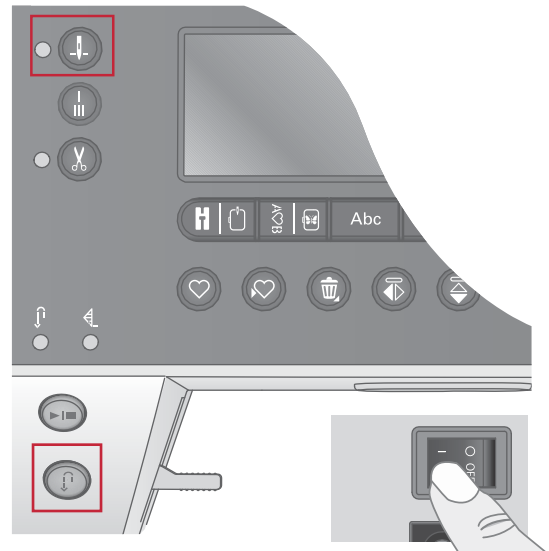

Buttons and Indicators

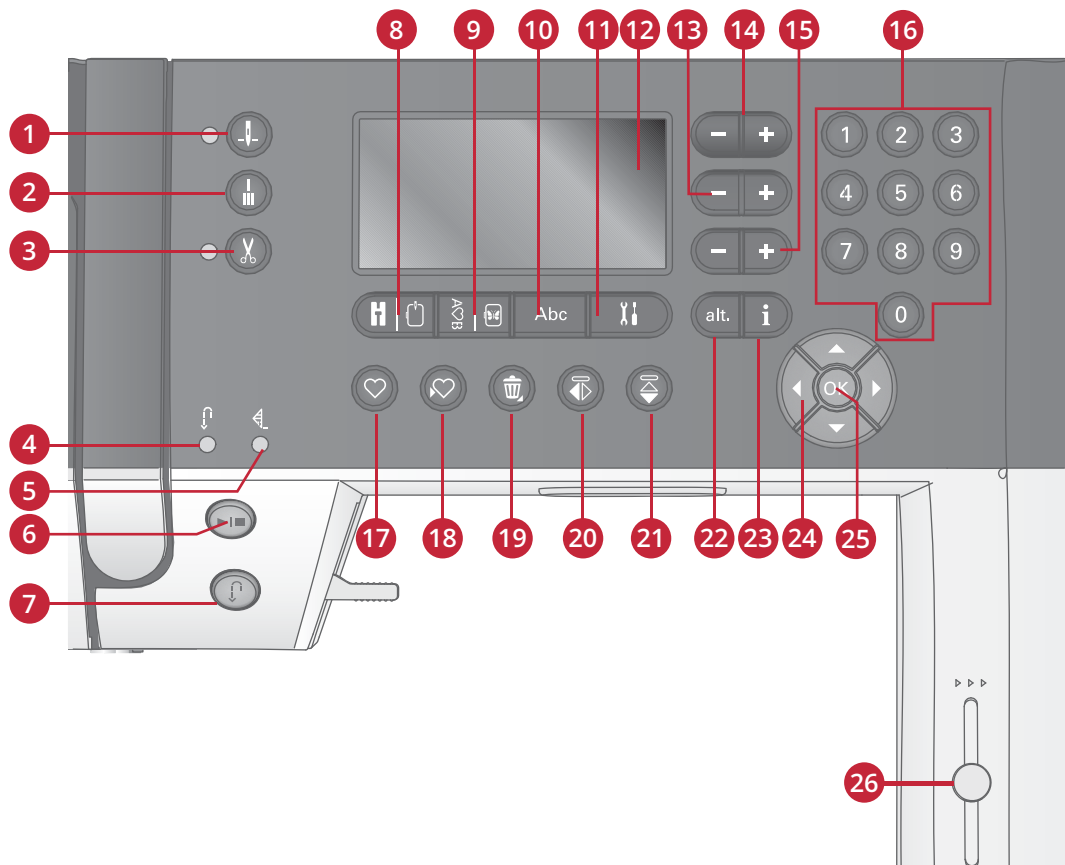

- | | | |
|---------------------------------------------------|---------------------------------------------|---------------------------------------------|
| 1. Needle stop up/down button with indicator | 9. Sequencing/embroidery edit mode button | 18. Save personal stitch or sequence button |
| 2. Tie-off button | 10. Alphabet mode, sequencing button | 19. Delete button |
| 3. Thread snips button with indicator | 11. Settings menu button | 20. Mirror side to side button |
| 4. Indicator for reverse (7) | 12. Graphic display | 21. Mirror end to end button |
| 5. Indicator for tie-off (2) | 13. Stitch width/stitch positioning buttons | 22. Alt button |
| 6. Start/stop button | 14. Cursor buttons | 23. Info button |
| 7. Reverse button with indicator (4) | 15. Stitch length/stitch density buttons | 24. Wheel buttons |
| 8. Sewing mode/ embroidery stitch-out mode button | 16. Direct selection buttons | 25. OK button |
| | 17. Load button | 26. Speed control lever |

Needle Stop Up/Down Button with Indicator

Press this button to move the needle up or down. The setting of the needle stop position is changed at the same time. When needle down is activated, the indicator is lit, the needle will stop in the down position. You can also tap the foot control to raise or lower the needle.

Tie-off Button

Press the tie-off button while sewing and your machine sews a few tie-off stitches and stops automatically. When pressed while not sewing, machine will sew a tie-off and stop automatically at the beginning of next sewing.

Thread Snips Button with Indicator

Press the button when you are not sewing and your sewing machine cuts the top and bobbin threads and raises the needle. The thread snips indicator will be lit. To cut before the needle moves to the start position of the next stitch, press the thread snips button while sewing. The indicators (3 & 5) will be lit and the machine will cut the threads after the stitch or sequence has completed.

Start/Stop Button

Press this button to start or stop the machine without using the foot control. Press the button once to start and press it again to stop.

Reverse Button with Indicator

For permanent reverse, press the button before starting to sew. The reverse indicator will be lit and the machine sews in reverse until you press the button again to cancel. If you press the reverse button while sewing, the machine sews in reverse for as long as you keep the button pressed. The reverse indicator is lit when the reverse button is pressed. Reverse is also used when sewing darning stitches.

Sewing Mode/Embroidery Stitch-out Mode Button

Press this button to enter sewing mode or embroidery stitch-out mode.

Sequencing/Embroidery Edit Mode Button

Press this button to enter sequencing. In embroidery mode, press this button to open embroidery edit mode.

Alphabet Mode, Sequencing Button

In Sequencing, press this button to create text sequences from various characters in two different fonts.

Settings Menu Button

Press this button to open the menu for machine settings.

Graphic Display

The graphic display lets you view all your selections and options. Stitches are shown in real size (except for buttonholes).

Stitch Width/Stitch Positioning Buttons

Increase or decrease the stitch width using the + and - buttons. For straight stitches, use the + and - buttons to change the stitch position.

In embroidery mode, use the + and - buttons to advance forward through the stitches or step backwards. They are also used for basting and adjusting height.

Cursor Buttons

By pressing the + and - buttons, cursor will move to right and left.

In embroidery mode, the + and - buttons are used to select hoop size, check position and rotation.

Stitch Length/Stitch Density Buttons

Increase or decrease the stitch length using the + and - buttons. For satin stitches, use the + and - buttons to change the density for the selected stitch.

In embroidery mode, use the + and - buttons to step between different color blocks forward/backward, to activate monochrome embroidery, or to adjust the width of a design.

Direct Selection Buttons

By pressing one of, or a combination of, the 0 to 9 buttons, you select the stitch represented by that number immediately.

In embroidery mode: select built-in design (1-15) or built-in font (curlz: 200, 201, 202 or graphite: 300, 301, 302).

Load Button

Press this button to load a previously saved personal stitch or sequence.

In embroidery mode, press this button to load an embroidery design or font from an USB embroidery stick.

Save Personal Stitch or Sequence button

Press this button to save a stitch or sequence to the machine's memory.

Delete Button

For deleting stitches and letters in a sequence. Long touch to delete the whole sequence.

Mirror Side to Side Button

For mirroring stitches and sequences side to side.

Mirror End to End Button

For mirroring stitches and sequences end to end.

Alt Button

When you select a satin stitch, the density settings will be shown on the graphic display. By pressing the alt button, the elongation will be shown instead of the stitch density.

In embroidery mode, this button is used to switch between two views of embroidery stitch-out.

Info Button

Press this button to toggle the recommendations view on and off.

Press this button in embroidery mode to display information about the loaded design.

Wheel Buttons

Use these buttons to move around the graphic display. The wheel has up and down arrow buttons, left and right arrow buttons and a center button, OK, to confirm your selections. The wheel has several functions, for example selecting letters and moving between options in the settings menu.

In embroidery mode, use the wheel to move the design in the hoop.

OK Button

The wheel center button, OK, is used to confirm your selections or clear messages on your screen.

Speed Control Lever

The speed control lever sets the maximum sewing/embroidery speed. To increase sewing/embroidery speed, slide the lever upwards, to decrease sewing/embroidery speed, slide the lever downwards.

Settings Menu

In the settings menu, you can adjust the machine settings, sound settings and screen settings. Open by pressing the settings menu button and select the setting you wish to adjust by pressing the up and down arrow buttons on the wheel. Use the left and right arrow buttons to adjust the values. Activate settings or open a list of choices by pressing OK. A solid box means a function is activated, an empty box means it is not activated.

Note: If a setting cannot be combined with a previously selected setting, the outlines of that box will be dashed. Different settings are available depending on whether you are in sewing or embroidery mode.

Press the settings menu button again to leave the settings menu.

Settings	
Thread tension	4.4
Twin needle	1.6 <input type="checkbox"/>
Stitch width safety	<input type="checkbox"/>
Language:	English

Thread Tension

Your sewing machine will electronically pre-set a thread tension for the selected stitch. Depending on the fabric, batting, thread etc, the tension may need to be adjusted. Use the left and right arrow buttons on the wheel to adjust the thread tension. The changes only affect the selected stitch. The setting will go back to default when you select another stitch.



 In sewing mode, press the info button to see the current selected thread tension.

Twin Needle

Activate the twin needle program and use the left and right arrow buttons on the wheel to set the twin needle width. When a twin needle size is selected, the width of all stitches is limited for that needle size to prevent needle breakage.

 In sewing mode, press the info button. The twin needle recommendation icon will be shown. The setting is kept until you deactivate it.

Note: Twin needle and stitch width safety cannot be used at the same time.

Note: A warning pop-up will be shown if you select a stitch that is too wide for the set twin needle size.

Stitch Width Safety

Select this function when using a presser foot for quilting, available as an optional accessory, to lock the center needle position for all stitches and prevent damage to the needle or presser foot.

 In sewing mode, press the info button. The stitch width safety icon will be shown. The setting is kept until you deactivate it.

When turning on the machine with this setting activated and for every stitch selection that is not a straight stitch, a pop-up informs you that the machine is set to straight stitch.

Note: Twin needle and stitch width safety cannot be used at the same time.

Automatic Stop for Cut

(Only in embroidery mode)

When starting to embroider the machine stops after a few stitches asking you to cut the thread end. Use the OK button to turn on or off this function in the settings menu.

Note: Automatic stop for cut is disabled if you use the foot control when embroidering.

Language

Use the left and right arrow buttons to change the language of all text in your machine.

Audible Alarm

Turn all alarm sounds of the machine on or off. Default setting is on.

Contrast

Adjust the contrast of the graphic display by using the left and right arrow buttons. The value can be set between -3 to 4 in steps of 1.

Software Version

Check the software version for your sewing machine.

Hoop Positions

(Only in embroidery mode)

Use the hoop position functions to move the hoop to different positions.

Current Position

When you want to return to the current stitch and start embroidering again where the embroidery was interrupted, use the wheel to select the current position and press OK. You can also press the start/stop button once to return to the current stitch and start to embroider.

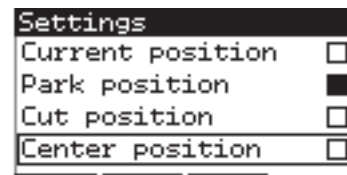

Park Position

When you have finished your embroidery, remove the hoop and open the settings menu. Use the wheel to select the park position option and press OK.



It is very important to remove the hoop before selecting park position, otherwise it may be damaged.

Cut Position

Cut position will move the hoop towards you, making it easier to cut jump stitches and trim fabric when embroidering an appliqué.

Center Position

Use the center position if you want to move the needle to the center position of the hoop.

3 Sewing Mode

Sewing mode is the first view on the graphic display after you turn on the machine. Your selected stitch will be shown in real size in the stitch field. Here you will find all the basic information you need to start sewing. This is also the menu where you adjust the settings of your stitch. Straight stitch is selected by default.

Note: It's not possible to sew with the embroidery unit attached.

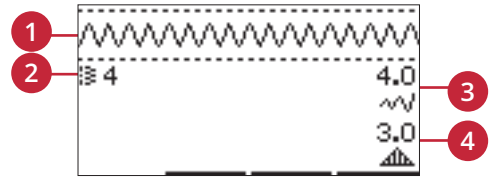

Sewing Mode — Overview

1. Stitch field
2. Selected stitch number
3. Stitch width/stitch positioning
4. Stitch length/density

Note: The tabs on the bottom of the screen indicates which mode is selected. The selected mode is indicated by the black tab disappearing on screen.

Select a Stitch

By pressing one of the direct selection buttons, you select that stitch number immediately. Press two or three digits in quick succession to select a stitch from 10 and up. If the stitch number does not exist, you will hear a beep and the last entered digit will be selected as a stitch. Use the up and down arrow buttons on the wheel to step between stitches.







Sewing Recommendations

Press the info button to show sewing recommendations for the current stitch. Press the button again to hide the information.



1. Needle recommendation/setting

-  Universal needle
-  Set for twin needle
-  Wing needle recommended
-  Set for stitch width safety

2. Presser foot recommendation
3. Stabilizer recommended
4. Thread tension value
5. Feed teeth/IDT™ system recommendation

Note: All symbols and options will not be shown at the same time.

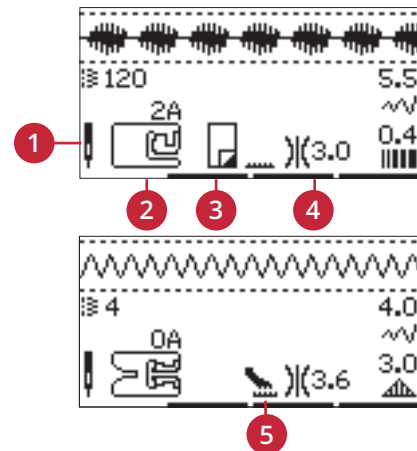

Stitch Adjustments

Your machine will automatically select optimal settings for each stitch. You can make adjustments to every stitch as desired. Adjusted settings only affect the selected stitch and will be reset to default when another stitch is selected. Adjusted settings are not automatically saved when the machine is turned off.

The values for stitch length and stitch width are shown to the right of the display. Use the next to the buttons numbers to make adjustments. When a setting is changed the numbers will be highlighted. When trying to exceed minimum or maximum settings for width and length, a warning sound will be heard.

Stitch Width/Stitch Positioning

Increase or decrease the stitch width using + and - buttons. For straight stitches, use + and - to move the stitch position left or right. When a straight stitch is selected, the icon changes to show that stitch positioning is active instead of stitch width.

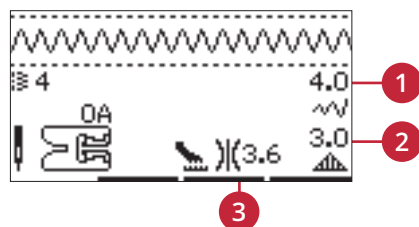

1. *Stitch width/ stitch positioning*
2. *Stitch length/ stitch density/elongation*
3. *Thread tension*

Stitch Length/Stitch Density

Increase or decrease the stitch length using + and - buttons.

For satin stitches, use the + and - buttons to increase or decrease the stitch density. This is often necessary when specialty threads are used or when a less dense satin stitch is desired. The stitch density does not affect the actual length of the entire stitch. When a satin stitch is selected, the icon changes to show that stitch density is active instead of stitch length.



Elongation

Elongation is used to lengthen satin stitches. The entire stitch will be longer but the density will remain the same. Press the alt button to show the elongation setting instead of density for satin stitches. The icon (3) changes to show an elongation symbol. Increase or decrease the elongation of the satin stitch using the + and - buttons. If elongation is not available for the selected stitch, a warning sound will be heard when pressing the alt button and the icon will not change.



Mirroring

To mirror stitches or sequences side to side, press the mirror side to side button. To mirror end to end, press the mirror end to end button.



Left: mirror side to side button. Right: mirror end to end button.

Thread Tension

For the best stitch appearance and durability, make sure the needle thread tension is correctly adjusted, i.e. for general sewing, the threads evenly meet between the two fabric layers. Your sewing machine electronically sets a thread tension for the selected stitch. Depending on the fabric, batting, thread etc, the tension may need to be adjusted. See page 30 for instructions on how to change the setting manually.

If the bobbin thread is visible on the top side of the fabric, the needle thread tension is too tight. Reduce the needle thread tension.

If top thread is visible on the underside of the fabric, the needle thread tension is too loose. Increase the needle thread tension.

For decorative stitches and buttonholes, the top thread should be visible on the underside of the fabric.

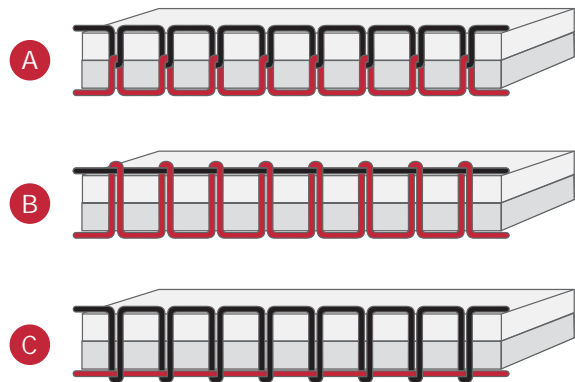

A. Correct tension

B. Tension too tight

C. Tension too loose

Personal Stitch

Save Personal Stitch

Save your personal stitch in your machine by pressing the save button. Adjustments in stitch length, width, density, elongation, mirroring and thread tension will be saved.

Note: Some special stitches, such as buttonholes, cannot be saved. A pop-up will inform you of this when you try to save such a stitch.



Overwrite Personal Stitch

If the memory is occupied, a pop-up message will appear asking if you wish to overwrite the previously saved stitch or sequence with the new one. Select Yes or No with the arrow buttons and press the OK.

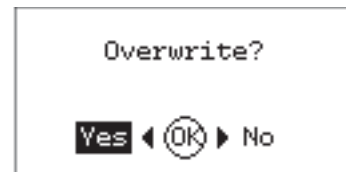

Load Personal Stitch

Load your personal stitch by pressing the load button.



Sewing Techniques

Three-Step Zigzag Stitch

Three-step zigzag stitch is used to overcast raw edges. Make sure the needle pierces the fabric on the left side and overcasts the edge on the right side. The stitch can also be used as an elastic stitch to allow seams to stretch when sewing knit fabrics.

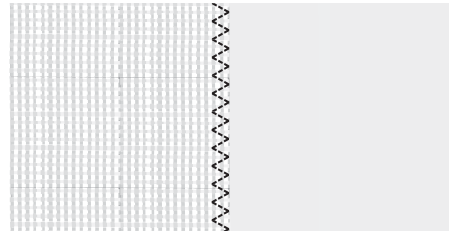

Stitch no. 8

Buttonholes

Your machine's buttonholes are specially adjusted for different kinds of fabric and garments. Look at the stitch table on page 11 in this book to find descriptions of each buttonhole.

The fabric should be interfaced and/or stabilized where buttonholes are to be sewn.

One Step Buttonhole Foot 5

1. Select the buttonhole you want to sew and adjust the width and density as desired (A).

Note: Always sew a test buttonhole on a scrap piece of fabric.

2. Mark the position of the buttonhole on your project.
3. On the One-Step Buttonhole Foot, push the button holder open by pushing it backwards (B). Insert the button. Push the button holder forward until the button is locked in place. The button will determine the length of the buttonhole.
4. Attach the One-Step Buttonhole Foot.
5. Make sure that the thread is pulled through the hole in the presser foot and placed under the foot.
6. Position your project under the presser foot so that the marking on the fabric is aligned with the center of the buttonhole foot.
7. Lower the buttonhole lever (C) all the way down.

Note: The machine will not start to sew if the buttonhole lever is not lowered properly or the frame of buttonhole foot is not positioned all the way forward.

8. Hold the end of the upper thread and start sewing. The buttonholes are sewn from the front of the presser foot to the back.
9. Once the machine has sewn the buttonhole, raise the presser foot.

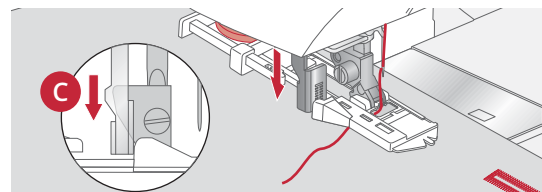
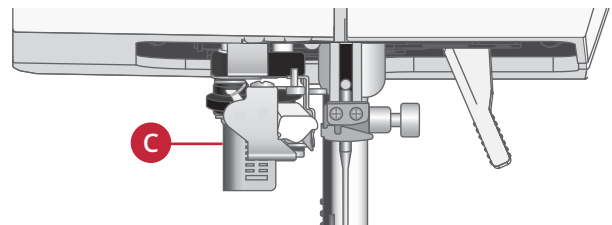
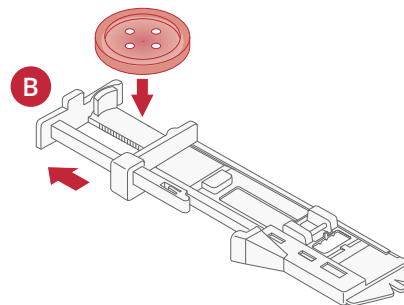

Manual Buttonhole

To sew a buttonhole longer than 25mm, use presser foot 5M.

1. Lower the buttonhole lever and presser foot. Press start/stop button or the foot control to start sewing while pushing the buttonhole lever away from you until the machine starts sewing a straight stitch backwards. Sew until you reach the desired length of the buttonhole.
2. Pull the buttonhole lever towards you until the machine starts sewing the first column forwards.
3. When the column stitching has reached your desired length, push the buttonhole lever away from you until the machine starts sewing a straight stitch backwards.
4. Pull the buttonhole lever towards you until the machine starts sewing the bar tack and second column forwards.
5. When the columns are aligned, push the buttonhole lever away from you until the machine starts sewing the bar tack. The machine will sew a few tie-off stitches and stop automatically. The machine cuts the top and bobbin thread and raises the needle.

Depending on style of buttonhole selected, the sewing sequence will differ, see illustration.

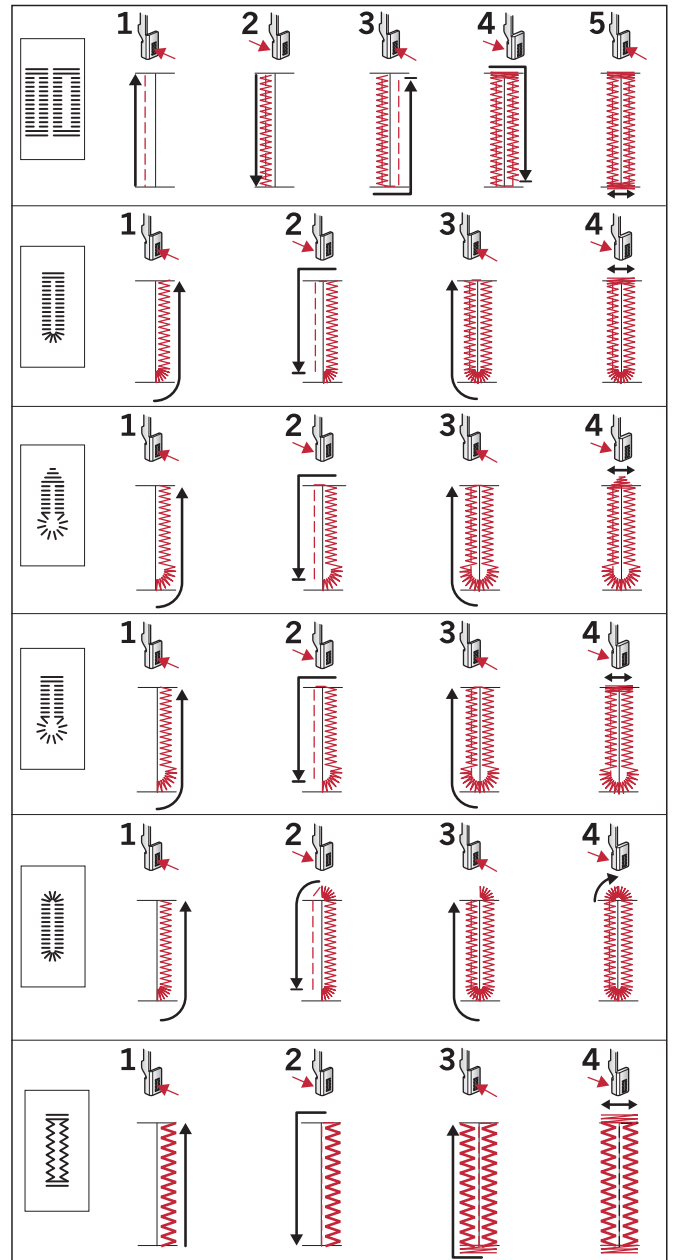

Sewing sequences for buttonhole stitches 25–31.

Corded Buttonhole

Corded buttonholes that are sewn with gimp threads are more stable, durable and have a professional appearance. Use pearl cotton or a regular gimp thread.

1. Loop a piece of heavy thread or pearl cotton over the metal bar extending from the center back of the 5M manual buttonhole foot or of the plastic bar of the 5 one step buttonhole foot. Pull the thread tails under the foot, towards the front, then secure around the finger at the front of the foot.
2. Stitch a buttonhole. The satin buttonhole columns will stitch over the cord.
3. When the buttonhole is finished, lift the cord off the finger and pull out the slack.
4. Cross the cord in front of the needle and thread cord ends into a large needle, pull to the wrong side and knot ends before cutting excess.
5. Use the seam ripper to carefully open the buttonhole.

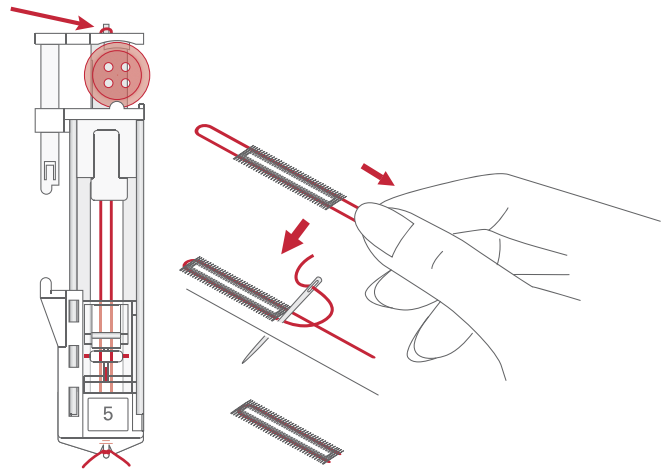

Sew On a Button

1. To sew on a button, remove the presser foot and select the button sewing stitch.
2. Lower the feed teeth.
3. Place the button under the presser foot holder. Use the mirroring function to make sure the holes in the button are aligned with the swing of the needle and the width is appropriate for the actual button. If necessary change the width between holes with the + and - buttons next to stitch width.
4. You can increase or decrease the number of stitches that will fasten the button on the fabric in steps of two, using the third row + and - buttons.
5. Start to sew. The machine will sew the program for you and then tie-off and stop.

Note: Use the multi-purpose tool to create a thread shank for your button. You can also use a sew-on button foot, available as an optional accessory at your local authorized PFAFF® dealer.

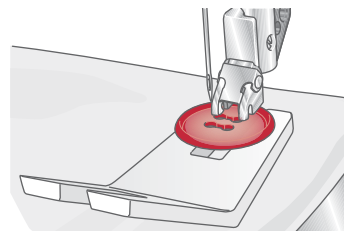

Darning

Darning a small hole or a tear before it becomes larger can save a garment. Choose a lightweight thread in a color as close to your garment as possible.

1. Place fabric or stabilizer in position under the hole or tear in your garment.
2. Select a darning stitch.
3. Start sewing above the hole and over it.
4. Once you have sewn across the hole, press the reverse button to set the length of the stitch. Your sewing machine will automatically complete the stitch.
5. By default, the machine will be set to repeat the same size darning square, just continue sewing.

Re-select the darning stitch to deactivate repeat.

Note: The reverse button icon (1) will disappear, indicating that repeat is activated.



Sewing Hems in Heavy Fabric

When sewing over seams in extra heavy fabric or a blue jeans hem, the foot can tip as the machine climbs over the seam. Use the multi-purpose tool to balance the height of the presser foot as you sew. One side of the multi-purpose tool is thicker than the other. Use the side that suits the thickness of the seam best.

Engage the IDT™ system, see page 22. At the thickest point on the fabric, slow down the sewing speed.

Note: Increasing the stitch length may improve the sewing result when sewing hems in heavy fabric.

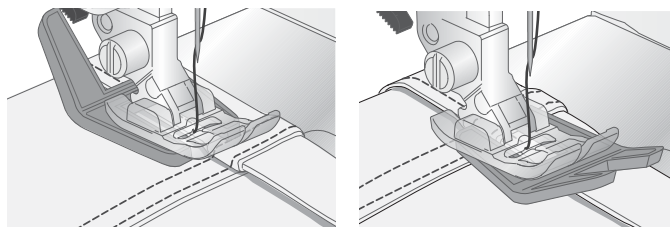

Handbook Quilting

A quilt usually consists of three layers, two layers of fabric with a layer of batting sandwiched between.

1. Baste the completed quilt top to the batting and backing.
2. Thread the needle with an invisible (monofilament) thread. Use needle size 90 and lightweight, soft cotton (60 wt or lighter) thread in the bobbin.
3. Select a quilt stitch and snap on the recommended foot shown in the sewing recommendations view.
4. Engage the IDT™ system.
5. When you sew the stitch you should only see your bobbin thread. You might need to adjust the thread tension depending on which fabric, thread and batting that is used. Make a few tests on a scrap piece of the fabric you are going to sew and check the tension.

Use the edge guide to sew successive rows. Loosen the upper screw of presser foot holder and insert edge guide into the hole. Set the space as you desire and tighten the screw.

	↗	┆	┆┆
38	39	40	41

Recommended stitches for a handbook quilt

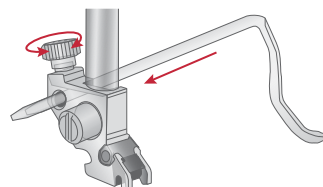

Free-Motion

For free-motion sewing lower the feed teeth on the back of the free arm. Attach the optional Open Toe Free-Motion foot. Move the fabric manually. Maintain a consistent speed and move the fabric in a smooth motion. You are creating the length of the stitch as you move the fabric.

Note: When free-motion sewing using zigzag, replace the short needle clamp screw with the long needle clamp screw found in the included accessories.

Note: When the feed teeth are dropped, the fabric is no longer fed by the machine. You must move the fabric.

Free-Motion Stippling

Free-motion stippling adds texture and interest to your quilt, while keeping the layers together. Free-motion stippling is done with the feed teeth lowered. You move the fabric manually to determine the stitch length.

1. Set your sewing machine for free-motion sewing with a straight stitch.
2. Attach the optional Open Toe Free-Motion foot. Disengage the IDT™ system and lower the feed teeth.
3. Begin by pin basting your quilt through all layers with safety pins, starting from the center of your quilt and working out. Place a pin every 6-8 inches (15-20 cm).

Note: Practice stippling on scraps of the fabric and batting from your quilt. It is important to move your hands at the same speed as the needle to prevent stitches that are too long or too short. Maintaining a consistent speed while free-motion sewing will also help keep stitches even.

4. Begin near the center of your quilt. Take one stitch and pull the bobbin thread to the top of the quilt. Take a few stitches right next to one another to lock the threads.
5. Plan a path for your stitching, then begin stitching your desired stipple pattern, moving the quilt as you go. The stitching should not cross over itself and should travel in a meandering motion.

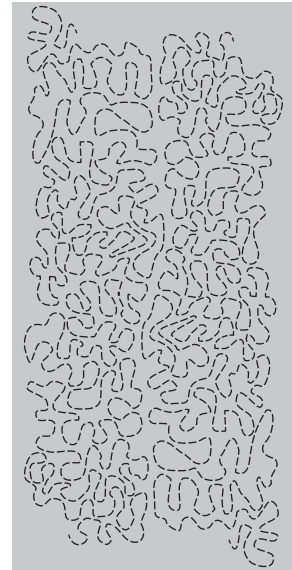

Blind Hem Stitch

The blindhem stitch is used to make invisible hems on skirts, trousers and home décor projects. Use foot number 3 with the IDT™ system.

1. Finish the edge of the hem.
2. Fold and press the hem allowance to the wrong side.
3. Fold the hem back on itself so approximately 3/8" (1 cm) of the finished edge extends beyond the fold.
The wrong side of your project should now be facing up.
4. Place the fabric under the presser foot so that the fold runs along edge guide (A).
5. When the needle swings into the fold it should catch a small amount of fabric. If the stitches are visible on the right side, adjust edge guide (A) by turning adjusting screw (B) until the stitch that catches the hem just barely shows.

The elastic blindhem stitch is especially suitable for stretchy fabrics, because the zigzag in the stitch lets the stitch stretch. The hem is finished and sewn at the same time. There is no need to finish the raw edge first on most knits.

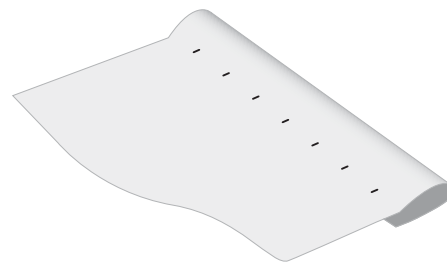
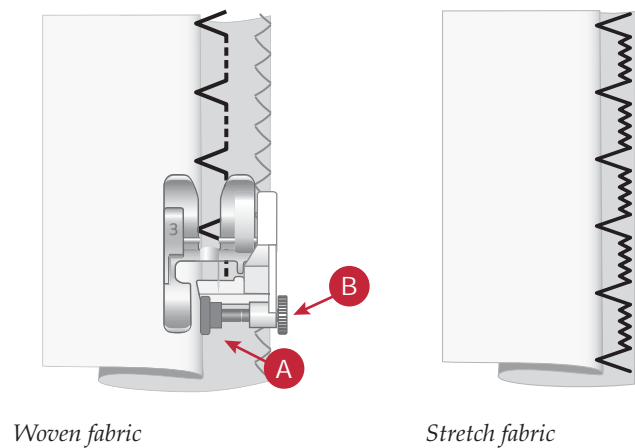

Right side of fabric

Sewing in Zippers

There are different ways to sew in zippers. Follow the directions included with your pattern for best results. For all types of zippers it is important to sew close to the teeth of the zipper. The zipper foot 4 can be snapped to the presser foot bar on the left or right, depending on how you will insert your zipper. Then set the stitch position so that it enters close to the edge of the zipper teeth by using one of the 29 needle positions available for the straight stitch. If the presser foot is attached on the right side, the needle must only be moved to the right. If the foot is attached on the left, the needle must only be moved to the left.

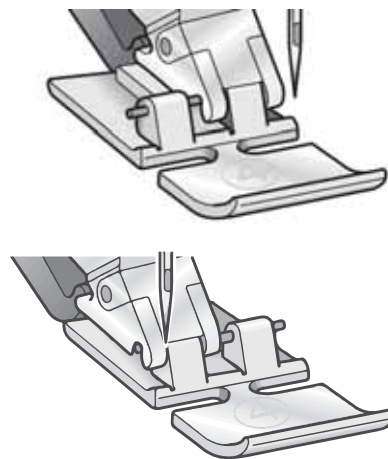

Sewing Pop-Ups

Raise Needle

Some functions are only possible with the needle raised. When trying to perform these functions with the needle lowered this pop-up message is shown. Raise the needle and press the OK button to close the pop-up message.

Please Lower the Presser Foot

Your machine will not sew if the presser foot is raised. Lower the presser foot and press the OK button to close the pop-up message.

Stitch Width Limited for Twin Needle

This message is shown when the machine is set for twin needle and you try to adjust the stitch width to wider than possible with the twin needle. Close the pop-up message by pressing the OK button.

Machine Set for Twin Needle

This pop-up message appears when the twin needle is activated and you turn on your machine. Press the OK button to close the pop-up message.

Remove Thread Jam Under the Stitch Plate

When this pop-up appears you need to clean the area under the stitch plate from thread and lint in order for the cut function to cut properly. Close the pop-up message by pressing the OK button.

This Stitch Cannot Be Combined With Twin Needle

This pop-up message appears when the machine is set for twin needle and you select a stitch that cannot be sewn with twin needle. Press the OK button to close the pop-up message.

This Stitch Cannot Be Sewn With Stitch Width Safety Active

This pop-up message appears when the machine is set for stitch width safety and you select a stitch that is wider than 0 mm. Press the OK button to close the pop-up message.

Machine Needs to Rest. Please Wait a Moment.

If the machine stops and this pop-up appears on the screen, the machine needs to rest. When the pop-up message closes you can resume sewing. The sewing results will not be affected.

Machine Set for Straight Stitch

This message is shown when the stitch width safety is on and you turn on the machine or try to adjust the stitch width or stitch position. Close the pop-up message by pressing the OK button.

Check Needle Thread

The machine stops automatically if the needle thread runs out or breaks. Re-thread the machine, press OK and start sewing again.

4 Sequencing

The sequencing function on your machine makes it possible to combine stitches and letters into sequences. You can add up to 60 stitches and/or letters in a sequence. Save your sequence on your machine; reload and sew any time you like. All stitches in your sewing machine can be used for sequencing except for buttonholes, darning stitch, button sewing and bar tack stitches.

Sequencing - Overview

1. Stitch field
2. Current stitch number
3. Stitch width/stitch positioning
4. Stitch length/density/elongation



Create a Sequence

1. Press the sequencing button to enter sequencing.
2. Select the stitch you wish to use (see page 32 on how to select a stitch). The stitch will appear in the stitch field.
3. Select a letter from the alphabet (2) using the arrow on the wheel and press OK to insert it. The letter will be placed at the cursor position in the stitch field.

Note: The current position in the stitch field is marked by a cursor. Inserted stitches will be placed at the cursor position. Move the cursor through the sequence using the - and + arrow buttons just to the right of the stitch field.



Using the Alphabet

Alphabet Mode, Sequencing- Overview

1. Stitch field
2. Alphabet
3. Character set (upper case/lower case, normal/special symbols)
4. Font selection



Create a Text Sequence

1. Press the alphabet mode, sequencing button.
2. Move the cursor through the stitch field (1) with the - and + buttons just to the right of the stitch field to where you want to add a letter.
3. Select a letter from the alphabet (2) using the arrow buttons and press OK to insert it. It will be placed at the cursor position in the stitch field.



Note: The selected letter in the alphabet will be highlighted.

Select Character Set and Font

Press the - or + buttons just to the right of the character set indicator (3) to change character set between upper or lower case, normal or special letters and symbols.

Press the - or + buttons just to the right of the font indicator (4) to change fonts.

Adjust Text and Stitches

Press the sequence button to enter sequence view. You can mirror, adjust length and width or change the density, elongation and stitch position of the selected stitch. The adjustments work just like in sewing mode. See page 33. When you have changed a value, the digits will be highlighted on the graphic display to show that the value is not default.

Note: The adjustments will only affect the stitch at the cursor position. If you return to sewing mode, all adjustments made there will affect the entire sequence and will not be saved you return to sequencing.

Delete a Stitch or Letter in a Sequence

If you want to delete a stitch, move the cursor to the stitch you want to delete and press the clear button. To delete the entire sequence from the stitch field, long press the delete button.



Manage Your Sequences

You can save and reload your sequence. The sequence memory has a space of 60 stitches and letters.

Save Sequence

Saving your sequence works just like in sewing mode. See page 34.

Note: If another sequence is already saved, a pop-up will appear asking if you wish to overwrite. Select yes or no with the arrow buttons and press OK.

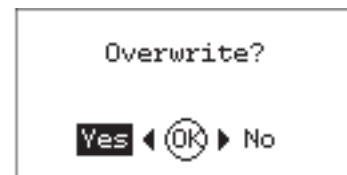

Load Sequence

Loading your sequence works just like in sewing mode, see page 34. To load your sequence, press the load button.

Note: When loading a sequence into sewing mode, the value displayed for the sequence will be the letter M.



Sewing a sequence

To sew the sequence, return to sewing mode by pressing sewing mode button, the start/stop button or by stepping on the foot control. Your sequence is ready to be sewn out. The sequence will be sewn continuously. If you want to stop at the end of the sequence, press the thread snips while sewing. The machine will tie-off and cut the threads at the end of the sequence.

Note: Adjustments made in sewing mode will affect the whole sequence. However, these adjustments will not be saved if you return to sequencing.



Sequencing Pop-Ups

This Stitch Cannot Be Added in a Sequence

This message is shown if you try to add a buttonhole, eyelet, bartack, darning stitch or the sew-on-button stitch (stitch numbers 25–37) to a sequence. All stitches in your sewing machine can be added in a sequence except for these. Close the pop-up message by pressing the OK button.

Sequence Out of Range

If you try to add more than 60 stitches or letters in the sequence this message is shown. Close the pop-up message by touching the OK button.

Overwrite?

If there is already a stitch or sequence saved in the machine memory and you press the save button this pop-up will appear asking if you wish to overwrite the previously saved stitch/sequence with the new one. Select yes or no with the arrow buttons and press the OK button.

This Stitch Cannot Be Saved

This message is shown if you try to save a buttonhole, eyelet, bartack, darning stitch or the sew-on-button stitch (stitch numbers 25–37) to the machine memory. All stitches in your machine can be saved except for these. Close the pop-up message by pressing the OK button.

Delete All Stitches?

This pop-up message will ask you to confirm when you have chosen to delete an entire sequence in sequencing mode. Select yes or no with the arrow buttons and press OK.

5 Embroidery Preparations

Embroidery Unit Overview

(type EU-3P)

1. Embroidery unit release button
2. Level adjusting feet
3. Embroidery unit socket
4. Embroidery hoop connection assembly
5. Embroidery arm

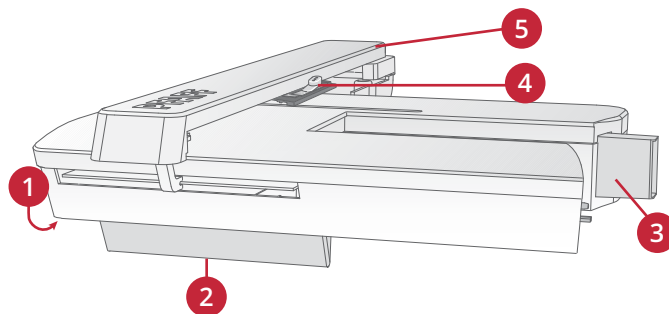

Embroidery Hoop Overview

- A. Embroidery hoop connector
- B. Outer hoop
- C. Inner hoop
- D. Quick release
- E. Retaining screw
- F. Ribs for fitting optional clips
- G. Center markings

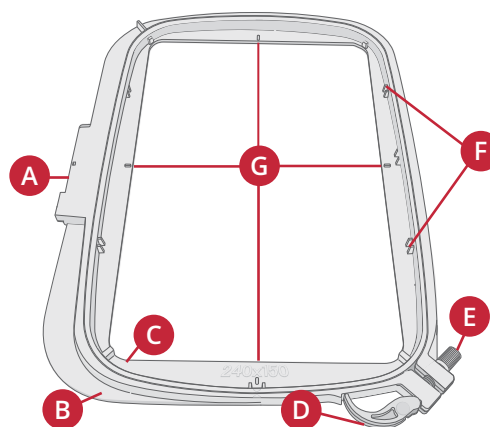

Designs

86 designs are stored on the USB embroidery stick delivered with your machine. We recommend copying the designs to your computer as an easily accessible backup if you should lose the USB embroidery stick or if you temporarily want to remove the designs from the stick.

Embroidery Collection

Page through the PFAFF® **creative™ ambition 640** embroidery collection booklet, found as a PDF-file on the USB embroidery stick, for an overview of the available designs and embroidery fonts. The design number, stitch count (number of stitches in the design) and the design size are displayed next to each design. The suggested thread colors for each color number are shown.

Download Backup Designs

All **creative™ ambition 640** designs and other files from the USB stick are also available on our website for backup. Go to PFAFF® website at www.pfaff.com, click on Support and select **creative™ ambition 640**. When downloading the files you will be asked to enter a code. Enter number:

8200creative

Connect the Embroidery Unit

There is a covered socket behind the free-arm, see illustration. The cover will open automatically when connecting the embroidery unit.

1. Make sure the machine is turned off.
2. Slide the accessory tray off.
3. Slide the embroidery unit onto the free arm of the machine until it plugs firmly into the socket. If needed, use the level adjusting feet so that the machine and embroidery unit are even.
4. Turn on the machine. It will automatically restart and enter embroidery mode.
5. Clear the embroidery area. A pop-up tells you to remove the hoop for positioning. Press OK. The machine will calibrate and the embroidery arm will move to the ready position.

 *Make sure not to calibrate the machine with the embroidery hoop attached as this can damage the needle, presser foot, hoop and/or the embroidery unit. Be sure to clear all materials from around the machine before calibrating so that the embroidery arm does not bump into anything while calibrating.*

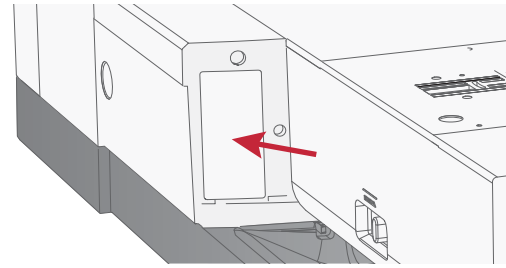

Remove hoop.
Disengage IDT.
Attach embroidery
presser foot.

OK

Remove the Embroidery Unit

1. To store the embroidery unit, move the embroidery arm to park position by selecting park position in the hoop options menu or the settings menu.
2. Make sure the machine is turned off.
3. Press and pull the button at the left, underneath the embroidery unit (A) and slide the unit to the left to remove it.
4. The cover of the socket closes automatically.
5. Store the embroidery unit in the original packing material.

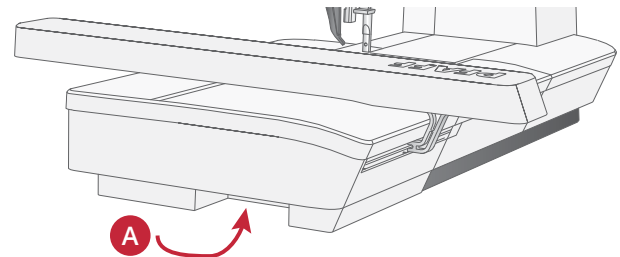

Attach Embroidery/Free-Motion Foot 6

1. Turn off the power switch to prevent accidents.
2. Turn the hand wheel toward you until the needle is at its highest point.
3. Disengage the IDT™ system and raise the presser foot.
4. Remove the presser foot and holder by removing the presser foot screw (A).
5. Attach the embroidery/free-motion foot 6 to the presser bar (B) so that the arm (C) of foot should ride on the shaft (D) of needle clamp. For embroidery, exchange the needle to an embroidery needle (E).
6. Attach the presser foot screw (A) and tighten it. For easier access, lower the needle slightly.

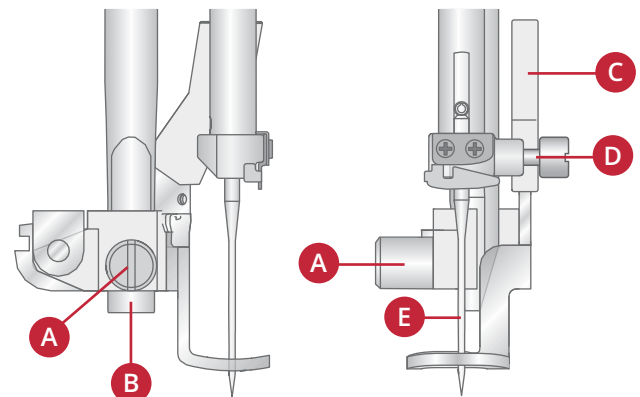

To Hoop the Fabric

For the best embroidery results, place a layer of stabilizer beneath the fabric. When hooping stabilizer and fabric make sure that they are smooth and securely hooped.

1. Open the quick release (A) on the outer hoop and loosen the screw (B). Remove the inner hoop. Place the outer hoop on a firm flat surface with the screw on the lower right (B). There is a small arrow in the center of the lower edge of the hoop which will line up with a small arrow on the inner hoop.
2. Place the stabilizer and fabric, with the right sides facing up, on top of the outer hoop. Place the inner hoop on top of the fabric with the small arrow at the bottom edge. If you can see the hoop size in the lower part of the inner hoop, you have attached it correctly.
3. Push the inner hoop firmly into the outer hoop.
4. Close the quick release (A). Adjust the pressure of the outer hoop by turning the retaining screw (B). The fabric should be taut in the hoop for the best results.

Note: When embroidering additional designs on the same fabric, open the quick release, move the hoop to the new position on the fabric and close the quick release. When changing type of fabric, you might need to adjust the pressure using the retaining screw. Do not force the quick release.

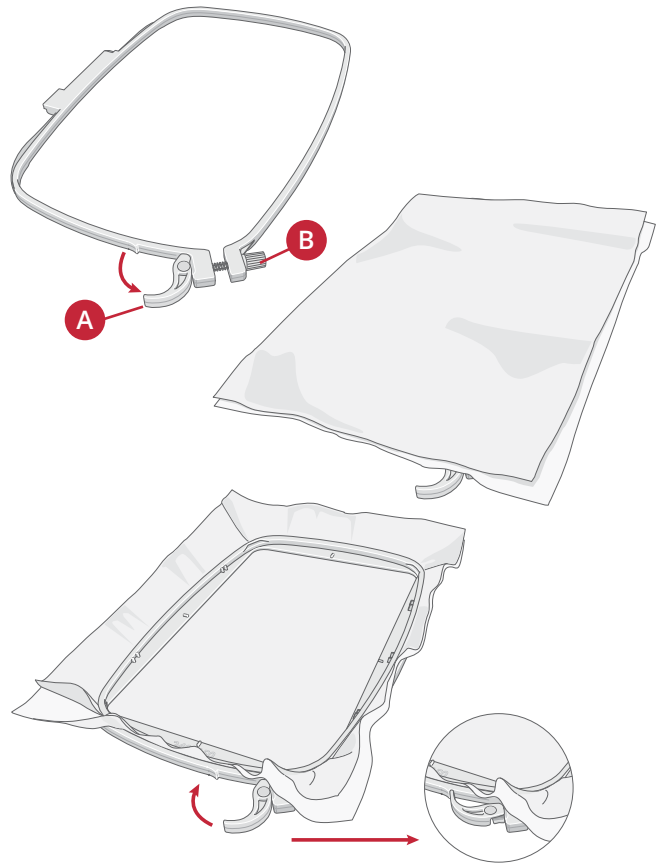

Attach/Remove the Hoop

Slide the hoop onto the embroidery arm from front to back until it clicks into place.

To remove the hoop from the embroidery arm, press the button (A) on the hoop connection assembly and slide the hoop towards you.

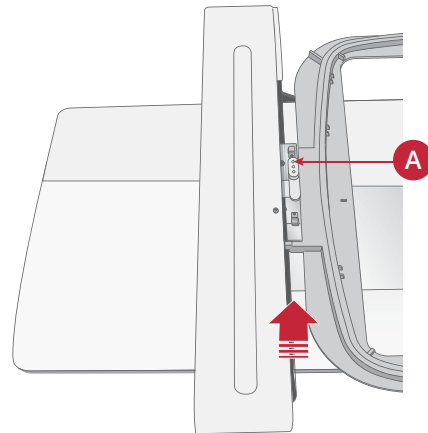

6 Embroidering

In embroidery mode you can adjust and stitch out designs. You need to have the embroidery unit connected to your machine to enter embroidery mode. After loading a design there are two views available in embroidery mode - stitch-out and edit.

Embroidery Stitch-Out View 1

1. Embroidery field
2. Loaded design
3. Hoop size
4. Stitches left in color block (total number of stitches left in design)
5. Current color (total number of colors)

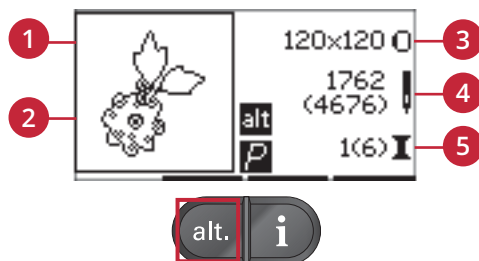

Embroidery Stitch-Out View 2

Press the alt button to toggle to view 2.

1. Orbit to check position
2. Basting
3. Monochrome embroidery



Embroidery Edit View

To adjust a design, press the embroidery edit button.

1. Rotate design
2. Design height
3. Design width

Note: Values that have been changed from default will be highlighted. The stitch out view will automatically be shown when starting to stitch-out your design

To return to the stitch-out view, press the stitch-out button.

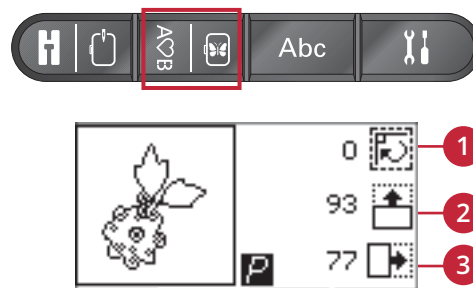

Design Information

Press the info button to view information about the loaded design.

Note: The machine will stop if you press the info button while machine is running.

Design Name/Number

Shows the name and number of the current design.

Design Position

Shows how many millimeters the design has been moved from the center position in the hoop.

Color List

All colors in the loaded design are shown in the order they will be embroidered. Each listed color shows order, name and thread type. Use the up and down arrow buttons to view all of the colors in the list.



1. Design name/number
2. Design position
3. Color list

Embroidery Stitch-Out

Load a Design

This machine has 15 built-in embroidery designs and 86 designs delivered on the USB embroidery stick. All designs can be viewed in the **creative™ ambition 640** embroidery collection booklet available as a PDF file on the USB embroidery stick.

Load Built-In Designs

With the embroidery unit connected, enter the number of desired design using the direct selection buttons. The design will be loaded into the embroidery field in embroidery stitch-out.

Load Designs From the USB Embroidery Stick

1. To load a design from the USB embroidery stick, insert the stick into the USB port on the right side of the machine with the embroidery unit attached and press the load button. Your machine can load .vp3 embroidery files.
2. Use the arrow buttons to select a folder and then press OK to open it. To go back to the previous folder, select the top line and press OK.
3. Select the design you want to load and press OK to confirm. It will be loaded into the embroidery field in embroidery stitch-out.

Note: If you have already loaded a design, the next design you load will automatically replace the first one.

When saving designs to the USB embroidery stick from your PC, make sure not to create too many levels of sub folders as this may create a file path that is too long. Also make sure to keep the file name short.

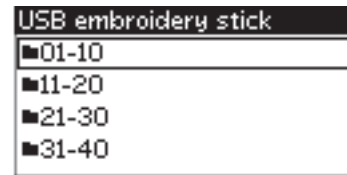
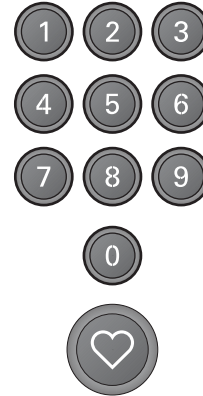

Load an Embroidery Font

This machine has 2 built-in fonts, curlz and graphite, in three different sizes. Select a font from **creative™ ambition 640** embroidery collection booklet and type in the font number (curlz: 200, 201, 202 or graphite: 300, 301, 302) using the keypad. The font will load into the embroidery text editor.

Load Fonts From the USB Embroidery Stick

You can create more embroidery font files using the embroidery intro software. See page 25.

1. Press the load button with the USB embroidery stick connected. Your machine can load .vf3 embroidery font files.
2. Select the font file you want to load and press OK to confirm. The font will load into the embroidery text editor.



Note: Font files are indicated with this symbol.

Embroidery Text Editor

An alphabet will be shown automatically when you have loaded a font. The embroidery text editor works just like sequencing, see page 43.

1. Create your embroidery text by selecting letters using the arrow buttons.
2. Confirm your selections by pressing OK.
3. Press second row - or + button to change character set.
4. When you want to sew your text, press the stitch-out button to bring the text to embroidery stitch-out. The square will now have the appearance of the loaded text.
5. Press the embroidery edit button to rotate or adjust the length and height of the text by pressing the corresponding + and - buttons.

Note: Press the alphabet mode, sequencing button to enter the embroidery text editor again. All adjustments made in stitch-out and edit mode will be cancelled if you go back to the embroidery text editor. A pop-up will appear asking if you wish to return to embroidery stitch-out. Select Yes to return to stitch-out mode. All your adjustments will remain. Select No to open the embroidery text editor. All adjustments made in stitch-out mode will be cancelled. Select Yes or No with the arrow buttons and press OK.



Embroidery Text Editor View

1. Text field
2. Alphabet
3. Character set (upper case/lower case, normal/special, symbols)
4. Text length information
5. Text height information

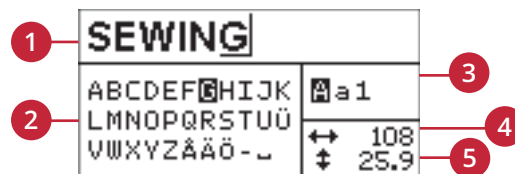

Hoop Sizes

Use the - or + buttons just to the right of the hoop size symbol to scroll through a list of available hoop sizes, including hoops that are available to purchase from your authorized PFAFF® dealer. Depending on the size of the design, some hoops may not be available for selection and the machine will beep.

Note: If you try to start embroidering and the hoop you have selected is not the same as the hoop attached to the embroidery unit, a pop-up will appear to inform you of this. Attach the correct hoop or select another hoop in the list.

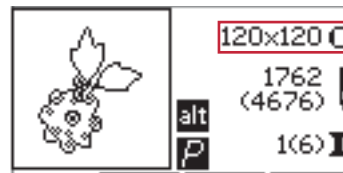

Stitch-out view 1

Hoop Positions

Open the settings menu to choose between different hoop positions.

Current Position

When you want to return to the current stitch and start embroidering again where the embroidery was interrupted, select the current position option. You can also press the start/stop button once to return to the current stitch and start to embroider.

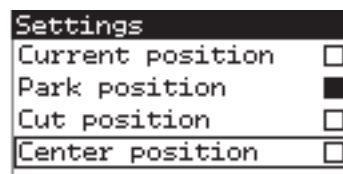

Park Position

When you have finished your embroidery, remove the hoop and select the park position option.

 *It is very important that the hoop is removed, otherwise it may be damaged.*

Cut Position

Cut position will move the hoop towards you, making it easier to trim fabric when embroidering an appliqué.

Center Position

Use the center position if you want to move the needle to the center position of the hoop.

Stitches Left in Color Block

The two values shown in the center position on the right side of the display indicate the number of stitches left in the current color block and the number of stitches left in the design (shown in brackets). Press the + or - buttons to step forward or backward stitch by stitch through the design. Step backwards a few stitches if the needle thread breaks or runs out.

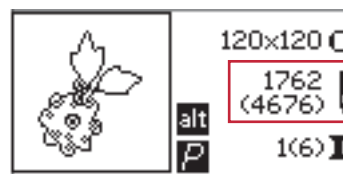

Stitch-out view 1

Current Color

The values displayed in the lower right corner denote the current color block and the total number of color blocks in the design (shown in brackets). Use the + and - buttons to move forward or backward through the color blocks.

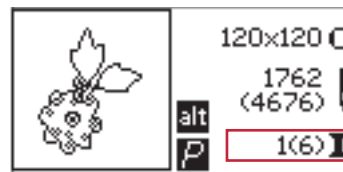

Stitch-out view 1

Orbit to Check Position

Orbiting can be used to trace the design area. Press the first row + button to move the hoop so the needle is placed in the upper left corner of where the design will be embroidered. Each time you press the + button the hoop will move to view all corners of the design. On the fifth press the hoop will move so the needle is above the center position of the design. On the sixth press it will move back to its original position. If the - button is pressed the hoop will move in reverse sequence. The hoop will first move to the center position of the design and then to each corner.



Stitch-out view 2

Basting

Press the second row - or + button and the machine will create a basting stitch around the design area.

Basting enables you to secure your fabric to a stabilizer placed beneath it, especially when the fabric to be embroidered cannot be hooped. Basting provides support for stretchy fabrics. It also shows where the design will be placed on the fabric.

Note: During basting the design box will be indicated with a dashed line.

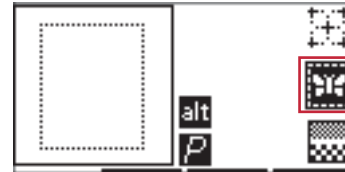

Stitch-out view 2

Monochrome

Press the third row - or + buttons to activate monochrome embroidery. The machine will not stop for color block changes. Press the button again to deactivate monochrome embroidery.

Note: When monochrome is activated, the design box will be indicated with a black frame.



Stitch-out view 2

Speed Control

Adjust the maximum embroidery speed by sliding the speed control lever up or down. It works just like in sewing mode, see page 29.

Thread Tension

When embroidering with specialty thread or fabric you may need to adjust the thread tension to achieve the best result. Thread tension can be adjusted in the settings menu, see page 30.

Getting Started Embroidering

1. Clear sufficient space to accommodate movement of the embroidery arm and the hoop.
2. Make sure the machine is turned off and slide the embroidery unit onto the free arm of the machine until it plugs firmly into the socket. Turn on the machine. It will automatically restart and enter embroidery mode. A pop-up tells you to remove the hoop for positioning. Press OK. The machine will calibrate and the embroidery arm will move to the ready position.
3. Make sure the IDT™ system is disengaged and attach the embroidery foot. Insert a bobbin with lightweight bobbin thread.
4. Select a design number from the machine by using the keypad or select one from a USB embroidery stick (make sure that the USB embroidery stick is connected) and press OK to load to embroidery stitch-out.
5. The design is placed in the center of the hoop.
6. Hoop a piece of fabric and stabilizer, and slide the hoop onto the embroidery arm.
7. Thread the machine with the first color in the color list.
8. Lower the presser foot. Hold the needle thread and press the start/stop button or the foot control. The machine starts embroidering and stops automatically after few stitches. A pop-up appears asking you to cut thread end. Cut thread end and press OK. Continue embroidering by pressing start/stop or the foot control.

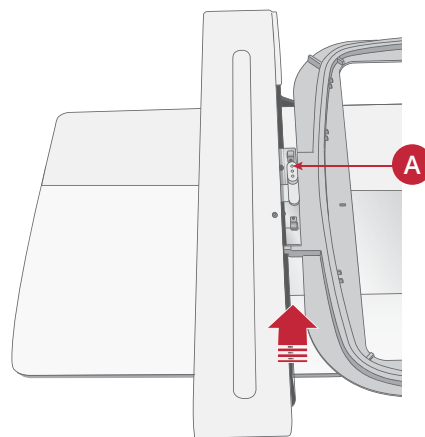
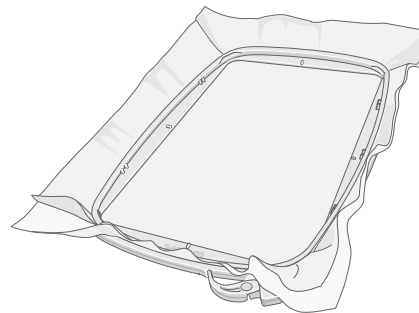

Note: Automatic stop for cut is activated by default. Open the settings menu to deactivate this setting. Automatic stop for cut is disabled if you use the foot control when embroidering.

9. When the first color is completed, your machine stops. A pop-up appears asking you to change color. Re-thread with the next color and press OK. Continue embroidering by pressing start/stop or the foot control. Each color segment is tied off at the end and the needle and bobbin threads are cut.
10. When the embroidery is completed, your machine cuts both threads and stops. A pop-up informs you that your embroidery is finished. Press OK. Raise the presser foot to easily remove the hoop.

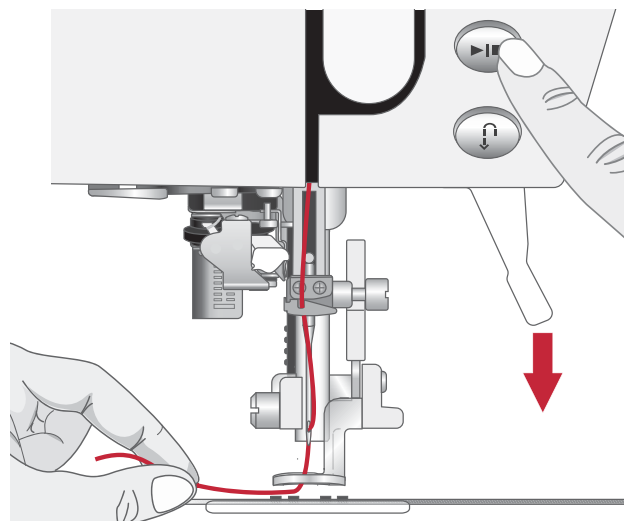

 <p>Cut thread end</p> <p>OK</p>	<p>Change thread color.</p> <p>New color: RaRa 2494 Cabernet</p> <p>OK</p>
<p>Embroidery finished</p> <p>OK</p>	

Embroidery Edit

To adjust your design, press the embroidery edit button. When you press the stitch-out button, the machine will switch to embroidery stitch-out.

Note: When you press the start/stop button or foot control, machine will automatically change to embroidery stitch out view and start stitching.

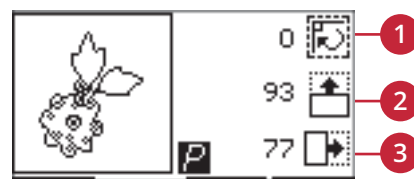

Rotate

You can rotate the design around its center point. Use the - and + buttons just to the right of the rotate icon to rotate. Each time you press the + button, the design will rotate 90 degrees clockwise. Press the - button to rotate the design counterclockwise. To the left of the rotate icon on the screen you can see how many degrees the design has rotated from its original position.

1. Rotate
2. Design height
3. Design width

Note: Some designs are too large to rotate in 90 degree increments. Each press of the button will then rotate 180 degrees. The P icon will rotate according to this setting, indicating the current orientation of the design in the embroidery area.

Design Height

You can increase or decrease the design height up to 20%. Use the + and - buttons just to the right of the design height icon. The design height is scaled 5% for each press.

Design Width

You can increase or decrease the design width up to 20%. Use the + and - buttons. The design width is scaled 5% each time you press a button.

Move

Use the wheel to move the design anywhere in the embroidery field. In the design information view you can see how far the design has been moved from its original position. Press the OK button to center the design in the hoop.



Mirroring

Use the mirroring buttons to mirror the design end to end or side to side. The icons will appear when these buttons are pressed.

Note: The P icon will mirror according to this setting.



Embroidery Pop-Ups

Remove Hoop. Disengage IDT.

Attach embroidery presser foot.

When the embroidery unit is attached, a pop-up asks you to remove the hoop and clear the machine area for calibrating the embroidery arm. Press OK. The machine will calibrate and the embroidery arm will move to the ready position.

Note: It is very important to remove the hoop, otherwise the hoop or the embroidery unit may be damaged while calibrating.

Embroidery Unit Not Supported. Please Replace Embroidery Unit

You can only use the embroidery unit that is delivered with your machine. Attach the correct embroidery unit.

Please Raise the Presser Foot

Some functions are only possible with the presser foot raised. When trying to perform these functions with the presser foot lowered this pop-up message is shown. Raise the presser foot and press the OK button to close the pop-up message.

Correct hoop not attached, please attach correct hoop.

When the size of the hoop on the machine does not match the size displayed on the graphic display, your machine will not sew. Change the hoop to the size displayed or change the setting for hoop size to match your selected hoop, see Hoop Sizes, page 51.

Change Thread Color

When it is time to change the needle thread the machine stops and the threads are cut. Change the spool and re-thread the machine. The next recommended color is shown in the pop-up message.

This pop-up message is also shown when your machine stops automatically for you to trim the fabric on cut work, applique etc. See explanation for each design in the **creative™ ambition 640** embroidery collection.

Read about the embroidery collection on page 45.

Embroidery Finished

A pop-up message informs you when the embroidery is finished. Press the OK button to close the pop-up message.

Cut Thread End

When starting to embroider or after changing the thread, the machine will sew a few stitches and then stop so you can cut the thread end.

Note: Automatic stop for cut is activated by default. Open the settings menu to deactivate this setting. Automatic stop for cut is disabled if you use the foot control when embroidering.

Calibration Failed

The machine was unable to calibrate. Clear the machine area for calibrating the embroidery arm and press the OK button.

Please Lower the Presser Foot

Your machine will not embroider if the presser foot is raised. Lower the presser foot and press the OK button to close the pop-up message.

Check Needle Thread

The machine stops automatically if the needle thread runs out or breaks. Re-thread the machine, press OK and continue embroidering by pressing the start/stop button or the foot control.

This Will Restart and Clear All Adjustments, Return to Stitch Out?

This pop-up message will appear if you press the sequencing mode button after starting the embroidery to go back to the text editor and change an existing embroidery text. If you select no the text editor will open and all your adjustments made in embroidery mode will be cancelled. If you select yes you will return to embroidery mode and all your adjustments will be kept. Use the arrow buttons to select yes or no and press the OK button.

Connect a USB Embroidery Stick

In embroidery mode if you press the load button without having a USB embroidery stick connected, this pop-up will appear. Connect a USB embroidery stick and press OK to load a design.

The Data On the USB Embroidery Stick Is Not Readable

This pop-up will appear when your sewing machine cannot access the information on the USB embroidery stick. This can be caused when incorrect file formats are saved to the USB embroidery stick. Other reasons could be that the USB embroidery stick is damaged or not compatible with the sewing machine.

Remove the hoop, then press OK

This pop-up will appear when a function has been chosen that forces the embroidery unit to move outside the limits for the attached hoop. In order for the embroidery arm to move freely, remove the hoop and then press OK.

This design is too large for the embroidery unit.

This pop-up message appears if the size of the design you are trying to load is too large or if the design contains too many stitches. Your machine can load designs containing up to 50.000 stitches. Press the OK button to close the pop-up and select another design.

Design Includes Elements That Cannot Be Opened

Some designs may consist of several designs or contain other elements that cannot be opened. Use your complimentary embroidery intro software to re-save the design as a combined design.

Stop Command in Design

This pop-up will appear when there is a programmed stop in the design. The machine will stop. Press OK to confirm and continue embroidering.

7 Maintenance

Cleaning the Machine

To keep your sewing machine operating well, clean it often. No lubrication (oiling) is needed. Wipe the exterior surface of your machine with a soft cloth to remove any dust or lint built up. Wipe the graphic display with a clean, soft and damp cloth.

Cleaning the Bobbin Area

 Lower the feed teeth and turn off the machine.

Remove the presser foot. Push the bobbin cover release button (A) to the right and remove the bobbin cover (B) and the bobbin. Use the screwdriver for the needle plate to remove the two screws (C) in the needle plate. Lift up the needle plate. Clean the feed teeth and bobbin area with the brush included with the accessories.

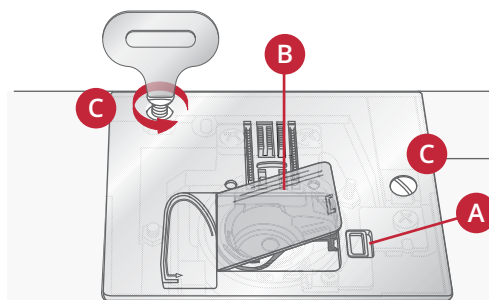

Cleaning Under the Bobbin Area

Clean the area under the bobbin case after sewing several projects or any time you notice an accumulation of lint in the bobbin case area. Remove the bobbin case by lifting it up. Clean the area with the brush or a dry cloth.

 Use caution when cleaning around the thread snips knife (B).

Put the bobbin case in place so that the tip (A) fits into the stopper (C).

Note: Do not blow air into the bobbin case area. The dust and lint will be blown into your machine.

Note: When using the optional accessory PFAFF® Embroidery Cutwork Needles, it is necessary to clean the bobbin area after each embroidered design/project.

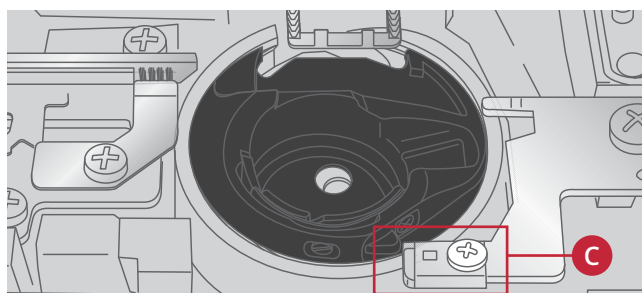
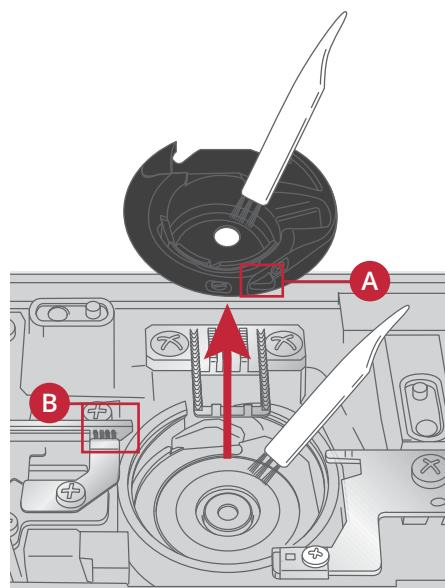

Replacing the Needle Plate

With the feed teeth lowered, replace the needle plate and insert and tighten the two needle plate screws.

Replace the bobbin cover.

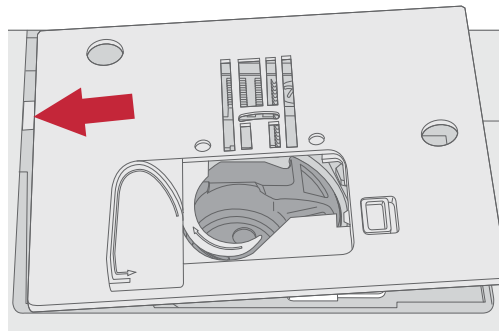

Troubleshooting

In this troubleshooting guide you will find solutions to the problems you may have with your machine. For further information please contact your local authorized PFAFF® dealer who will be happy to help you.

Have your sewing machine serviced regularly by your local authorized PFAFF® dealer!

If you have followed this trouble shooting information and still have problems, take your sewing machine to your dealer. If there is a specific problem, it is a great help to test sew with your thread on a scrap of your sewing fabric and bring it to your dealer. A sewing sample will often give much better information than words.

Non-original parts and accessories

The warranty does not cover any defect or damage caused by use of non-original accessories or parts.

General Problems

Thread snips do not cut the thread?	Remove needle plate and clean lint from bobbin area.
Fabric does not move?	Make sure that the feed teeth are not lowered.
Wrong stitch, irregular or narrow stitch?	Deactivate twin needle or stitch width safety in the settings menu.
The needle breaks?	Insert needle correctly as described, see page 23. Attach correct needle for the fabric.
The machine will not sew?	Check that all plugs are securely plugged into the machine and into the wall socket. Check that the foot control cord is securely plugged into the front socket on the bottom right side of the machine. Push bobbin winder lever to sewing position.
The sewing and embroidery machine function buttons do not respond to touch?	The sockets and function buttons on the machine can be sensitive to static electricity. If the buttons do not respond to touch, turn the machine OFF and then ON again. If the problem persists, contact your local authorized PFAFF® dealer.

The Machine Skips Stitches

Did you insert the needle properly?	Insert needle correctly as described, see page 23.
Did you insert a wrong needle?	Use needle system 130/705 H.
Is the needle bent or blunt?	Insert a new needle.
Did you thread the machine properly?	Check how the machine is threaded.
Is the correct presser foot used?	Attach correct presser foot.
Is the needle too small for the thread?	Make sure the needle is correct for the thread and fabric.

Needle Thread Breaks

Did you insert the needle properly?	Insert needle correctly as described, see page 23.
Did you insert a wrong needle?	Use needle system 130/705 H.
Is the needle bent or blunt?	Insert a new needle.
Did you thread the machine properly?	Check how the machine is threaded.
Is the needle too small for the thread?	Change the needle to the proper size for the thread.
Are you using poor thread with slubs or thread which has become dry?	Change to a new higher quality thread purchased from an authorized PFAFF® dealer.
Is a correct spool cap used?	Attach a spool cap of the right size for the actual thread spool.
Is the best spool pin position used?	Try a different spool pin position (vertical or horizontal).
Is the needle plate hole damaged?	Change the needle plate.

Bobbin Thread Breaks

Did you insert the bobbin properly?	Check the bobbin thread.
Is the needle plate hole damaged?	Change the needle plate.
Is the bobbin area clean?	Clean lint from bobbin area and use only the bobbins approved for this model.
Is the bobbin wound correctly?	Wind a new bobbin.

The Seam Has Uneven Stitches

Is the thread tension correct?	Check needle thread tension and the threading.
Are you using too thick or slubbed thread?	Change the thread.
Is the bobbin thread evenly wound?	Check bobbin winding.
Is a correct needle used?	Insert a proper needle correctly as described in see page 23.

The Machine Does Not Feed or Feeds Irregularly

Did you thread the machine properly?	Check how the machine is threaded.
Has sewing lint collected between the feed teeth?	Remove the needle plate and clean the feed teeth with a brush.
Are the feed teeth raised?	Raise the feed teeth.

Unable To Sew a Buttonhole

Machine beeps when using the One step buttonhole foot 5 ?	Make sure the accessory tray is attached to the machine and the buttonhole lever is lowered all the way down. Lower the presser foot gently.
-----------------------------------------------------------	----------------------------------------------------------------------------------------------------------------------------------------------

The Embroidery Design is Distorted

Is the fabric hooped properly?	The fabric must be tightly hooped.
Is the inner embroidery hoop completely inserted in the outer embroidery hoop?	Hoop the fabric in such a way that the inner hoop always exactly matches the outer hoop.

The Embroidery Design has Puckered

Did you stabilize your fabric sufficiently?	Ensure you use the proper stabilizer for your technique or fabric type.
---------------------------------------------	-------------------------------------------------------------------------

The Machine Will Not Embroider

Is the embroidery unit attached?	Make sure that the embroidery unit is properly attached into the socket.
Is the wrong hoop attached?	Slide on the correct hoop.

Technical Specification

Sewing Machine

Rated voltage	100–240V ~ 50–60Hz
Nominal consumption	55W
Light	LED
Sewing speed	800 rpm maximum
Machine dimensions:	
Length (mm)	480
Width (mm)	193
Height (mm)	300
Net weight (kg)	13

Foot Control

Model	C-9000
Rated voltage	DC 15V, max. 3mA

The technical specifications and this owner's manual can be changed without prior notice.

You have purchased a modern, updatable sewing and embroidery machine. As we regularly release software updates, it is possible that there may be some differences between the machine software and the software described in the User's Guide. Consult your local Authorized PFAFF® retailer, and be sure to visit our website at www.pfaff.com for the latest updates of the software and the User's Guide.

We reserve the right to change the machine equipment and the assortment of accessories without prior notice, or make modifications to the performance or design. Such modifications, however, will always be to the benefit of the user and the product.

INTELLECTUAL PROPERTY

AMBITION, CREATIVE, IDT, PFAFF, and PERFECTION STARTS HERE are trademarks of KSIN Luxembourg II, S.ar.l.



Please note that on disposal, this product must be safely recycled in accordance with relevant National legislation relating to electrical/electronic products. Do not dispose of electrical appliances as unsorted municipal waste, use separate collection facilities. Contact your local government for information regarding the collection systems available. When replacing old appliances with new ones, the retailer may be legally obligated to take back your old appliance for disposal free of charge.

If electrical appliances are disposed of in landfills or dumps, hazardous substances can leak into the groundwater and get into the food chain, damaging your health and well-being.

Manufacturer

VSM GROUP AB, SVP Worldwide

Soldatorpsgatan 3, SE-55474, Jonkoping, SWEDEN

PFAFF
Perfection starts here.™

160
Y E A R
ANNIVERSARY



www.pfaff.com